



EDISON Data Science Framework (EDSF):  
Facilitating Data Science Curricula Development  
and organisational capacity building

## EDSF Components and Practical Usage



**EDISON**  
building the data  
science profession

EDISON – Education for **D**ata Intensive  
**S**cience to **O**pen **N**ew science frontiers

H2020 INFRASUPP Grant 675419 (2015-2017)

Yuri Demchenko, EDISON Project  
University of Amsterdam

31 May 2018, Amsterdam





# Workshop Agenda

## Part 1 10:00 – 13:00

1. Introduction and bootstrapping (30 min)
  - EDISON Data Science Framework and EDISON project legacy.
  - Workshop goals and attendees interests
2. Background information and how the EDSF has been done (60 min)
  - EU and International studies on data related competences and skills
  - EU standards, projects, initiatives, associations
3. EDISON Data Science Framework (EDSF) in details and walk through customised curriculum design (90 min)
  - EDSF components: Competence Framework (CF-DS), Body of Knowledge (DS-BoK), Model Curriculum (MC-DS), Data Science Professional Profiles (DSPP)
  - Walk through customised curriculum design: from target professional groups or competences to curriculum suggestions

## Part 2 14:00-16:00+

1. Curriculum analysis and design – Interactive session and practice (in groups)
  - Analysis of Data Science and Data Management curricula by champion universities adopting EDSF
  - Continue with the curriculum design for target professional groups or study programmes
  - Assessment and discussion on Data Science soft skills: workplace and 21st Century
2. Critical issues in implementing research and enterprise Data Science capacity building and Data Management practices: skills management, team building, infrastructure issues.
  - Interactive session and open discussion
3. Closing: comments, future steps, community building



# Outline

- Data Scientist definition
- EDSF components
  - CF-DS, DS-BoK, MC-DS, DSPP
  - Data Science Soft and Workplace skills
  - MC-DS and related teaching technologies
- Curriculum design approach
- Competences assessment and Team building
- Data Management and Governance and Research Data Management curricula
- How to become a Data Scientist
  - Online self-learning resources



# Challenge for Education: Sustainable ICT and Data Skills Development

- Educate vs Train
  - Training is a short term solution
  - Education is a basis for sustainable skills development
  - *Importance of workplace or professional attitude skills (not covered in academic curricula)*
- Technology focus changes every 3-4 years
  - **Study: 50% of academic curricula are outdated at the time of graduation**
- Lack of necessary skills leads to *underperforming projects* and organisations and *loose of competitiveness*
  - Challenge: Policy and decision makers still don't include planning human factor (competences and skills) as a part of the technology strategy
- Need to change the whole skills management paradigm
  - **Dynamic (self-) re-skilling:** Continuous professional development and **shared responsibility between employer and employee**
  - Professional and workplace skills and career management as a part of professional orientation
- Millennials factor and changing nature of workforce



# Data Scientist definitions: From Math to Hacking

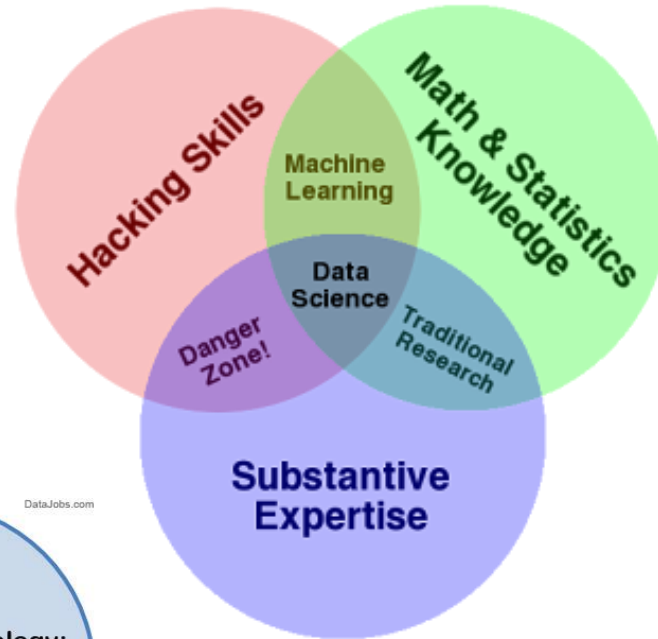

- Strongly depend on the background of the Data Scientist

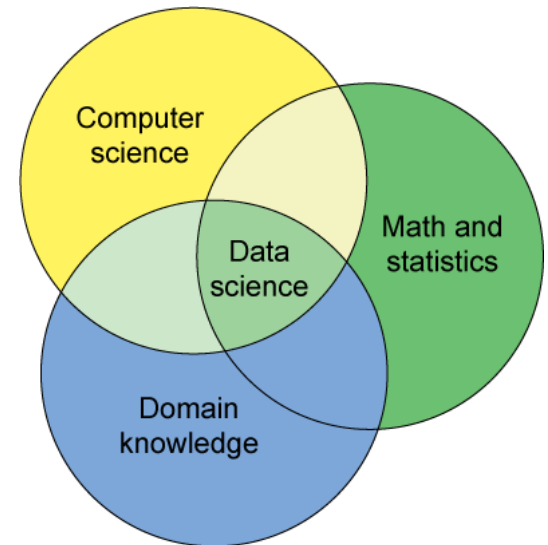
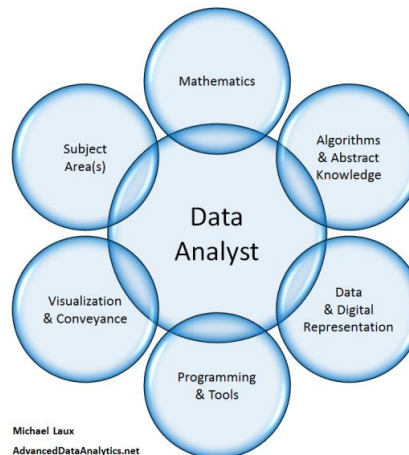
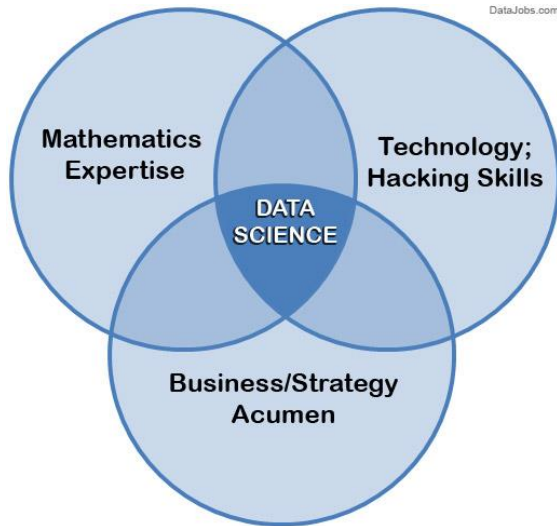

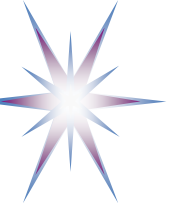

# Becoming a Data Scientist by Swami Chandrasekaran (2013)

<http://nirvacana.com/thoughts/becoming-a-data-scientist/>

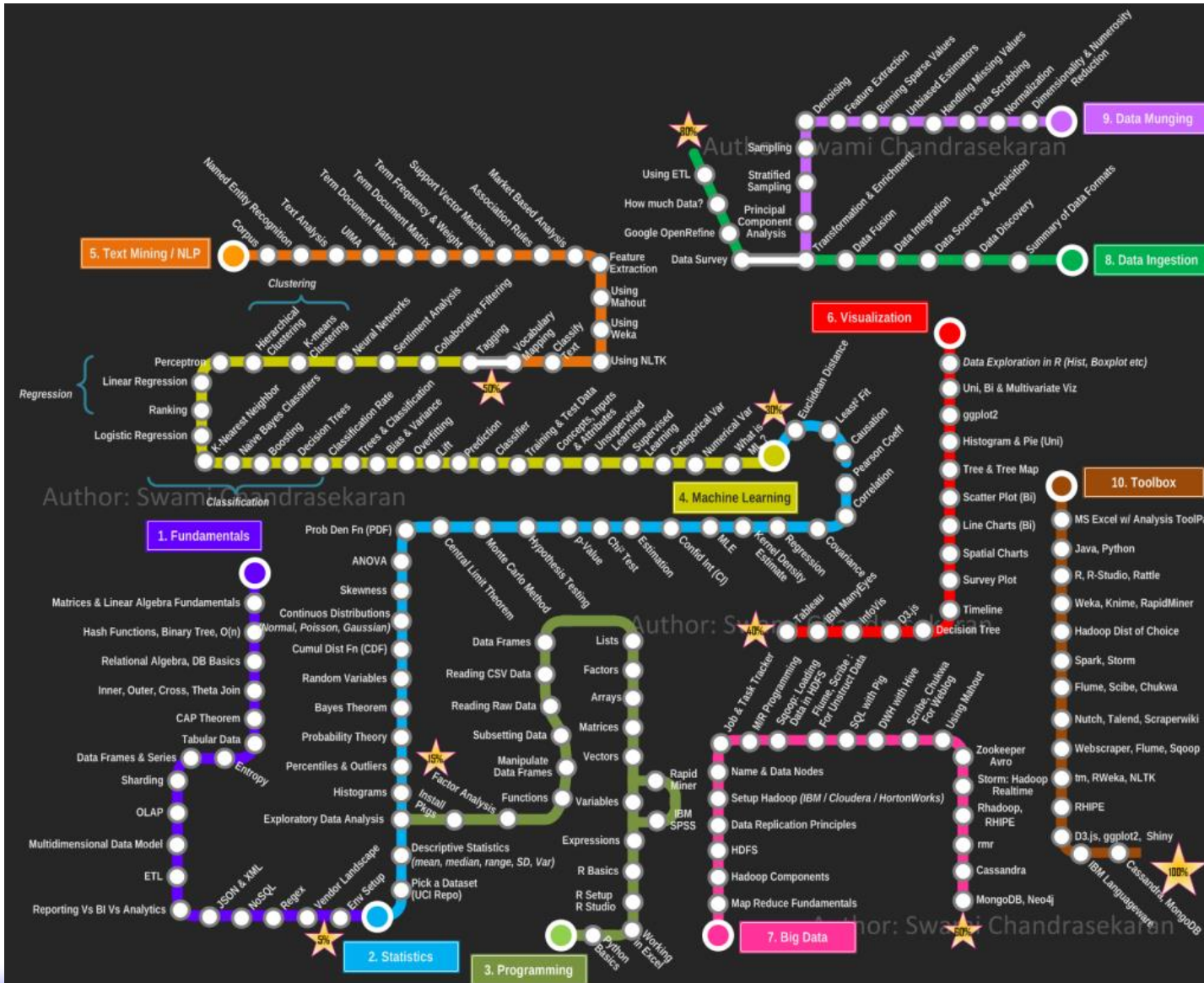

- Good and practical advice how to learn Data Science, step by step
- Follow the route

# EDISON Data Science Framework (EDSF)

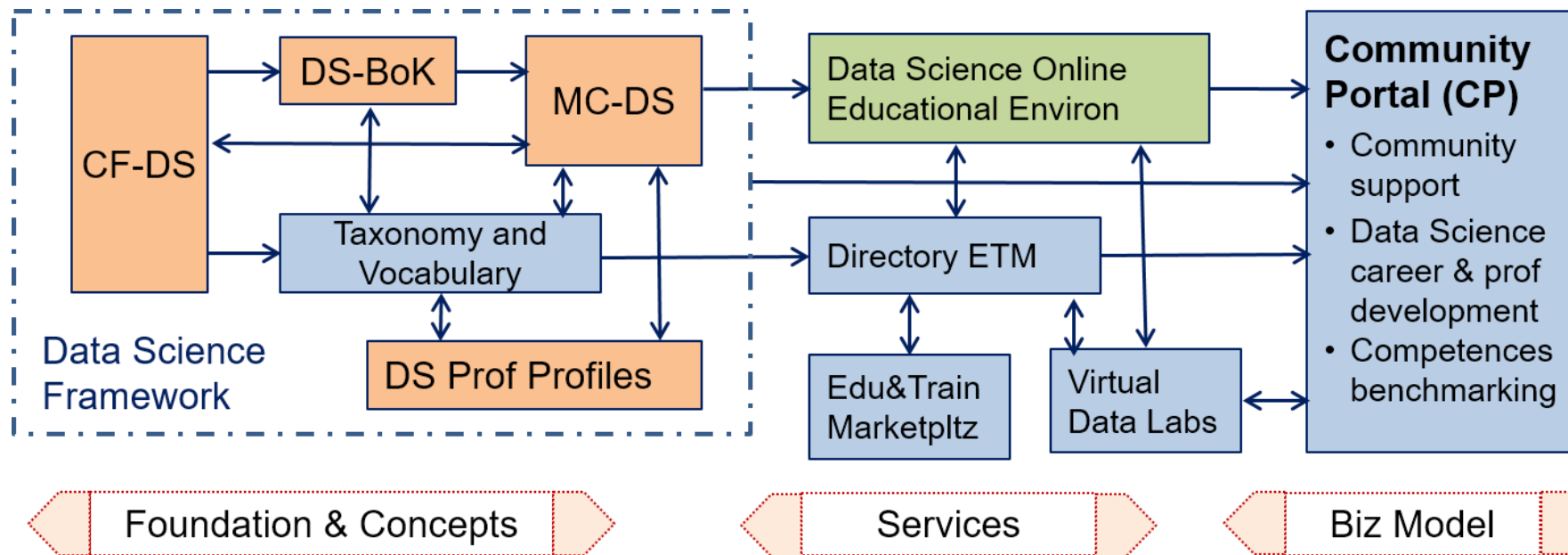

## EDISON Framework components

- CF-DS – Data Science Competence Framework
- DS-BoK – Data Science Body of Knowledge
- MC-DS – Data Science Model Curriculum
- DSP – Data Science Professional profiles
- Data Science Taxonomies and Scientific Disciplines Classification
- EOEE - EDISON Online Education Environment

## Methodology

- ESDF development based on job market study, existing practices in academic, research and industry.
- Review and feedback from the ELG, expert community, domain experts.
- Input from the champion universities and community of practice.

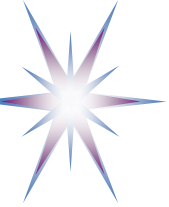

# What challenges related to skills management the EDSF can help to address?

1. Guide researchers in using right methods and tools, latest Data Analytics technologies to extracting value from scientific data
2. Educate and train RI engineers dev to build modern data intensive research infrastructure and understand trends and project for future
3. Develop new data analytics tools and ensure continuous improvement (agile model, DevOps)
4. Correctly organise and manage data, make them accessible (adhering FAIR principles), education new profession of Data Stewards
5. Help managers to facilitate career dev for researchers and organise effective teams
6. Ensure skills and expertise sustain in organisation
7. Help research institutions to sustain in competition with industry and business in data science talent hunting



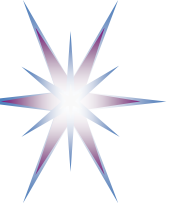

# EDSF Background: **Used Standards and Best Practices**

- e-CFv3.0 - European e-Competence Framework for IT
  - Structured by 4 Dimensions and organizational processes
    - Competence Areas: Plan – Build – Run – Enable - Manage
    - Competences: total defined 40 competences
    - Proficiency levels: identified 5 levels linked to professional education levels
    - Skills and Knowledge
- CWA 16458 (2012): European ICT Professional Profiles Family Tree
  - Defines 23 ICT profiles for common ICT jobs
- ESCO (European Skills, Competences, Qualifications and Occupations) framework
  - Standard for European job market since 2016
  - Expected inclusion of the Data Science occupations family – end 2017
- ACM Classification of Computer Science – CCS (2012)
- ACM Computer Science Body of Knowledge (CS-BoK) and ACM and IEEE Computer Science Curricula 2013 (CS2013)
- NIST SP 1500-1 NIST Big Data interoperability Framework (NBDIF): Volume 1: Definitions, September 2015



# EDSF vs e-CF and IT Leadership

- e-CF is the European e-competence Framework
  - Result of more than 14 yrs work, currently moved to CEN
  - Defines IT related Competences and corresponding Knowledge and Skills
  - Linked to organisational processes
- EDSF defines the main components of the competences and skills management ecosystem
  - Defines Data Science and data related Competences, corresponding Knowledge and Skills, Body of Knowledge, Model Curriculum
  - Tailored curriculum design for education and professional training
  - Individual workplace training and up/re-skilling
  - Personal skills management
  - Interactive tools and toolkits for organisations
  - Provides common basis for Academia, Research, Industry

# Competences Map to Knowledge and Skills

- **Competence** is a demonstrated ability to apply knowledge, skills and attitudes for achieving observable results

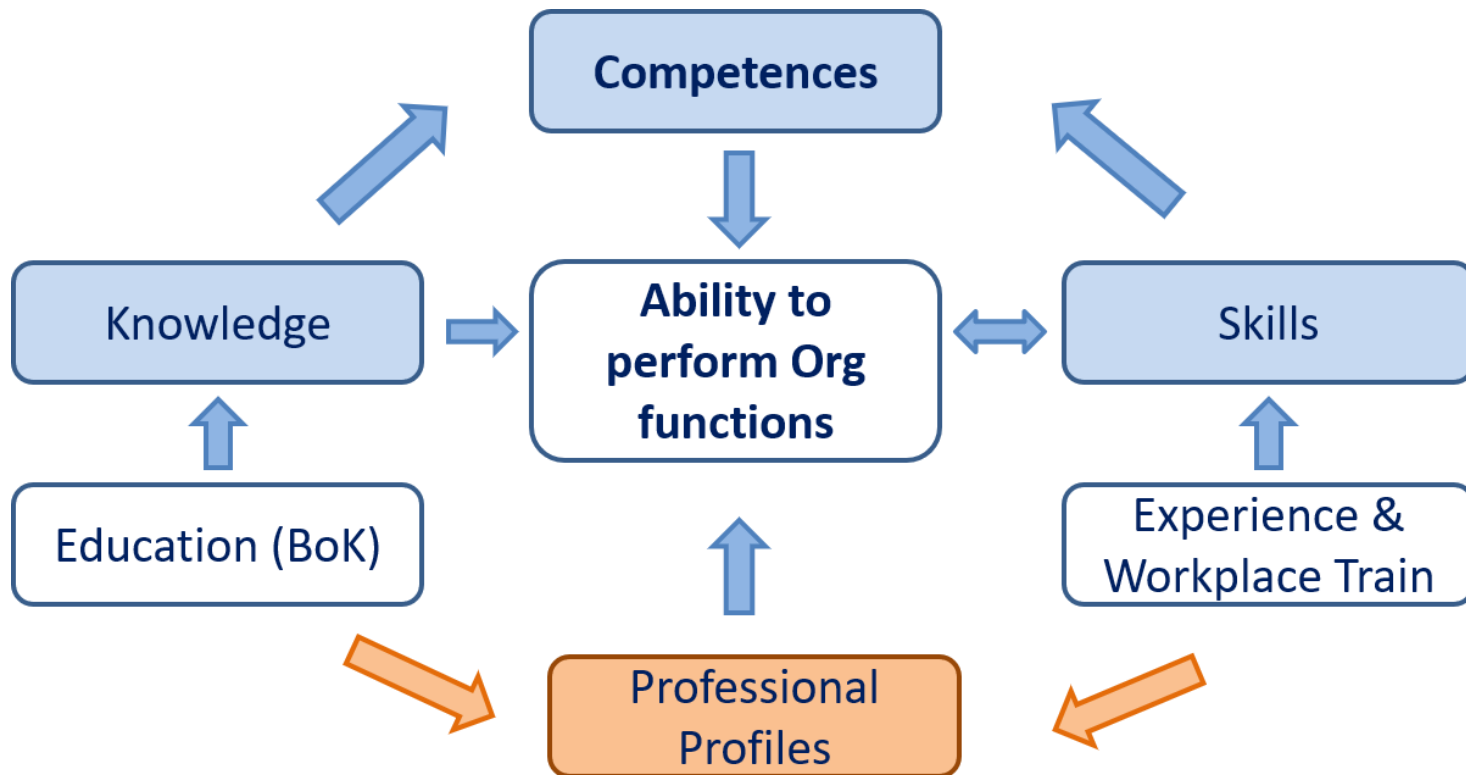



# Data Scientist definition

Based on the definitions by NIST SP1500 – 2015, extended by EDISON

- A **Data Scientist** is a practitioner who has sufficient knowledge in the overlapping regimes of expertise in **business needs, domain knowledge, analytical skills, and programming and systems engineering expertise** to manage the end-to-end scientific method process through each stage in the **big data lifecycle** till the delivery of an **expected scientific and business value** to organisation or project.
- Core Data Science competences and skills groups
  - **Data Science Analytics** (including Statistical Analysis, Machine Learning, Business Analytics)
  - **Data Science Engineering** (including Software and Applications Engineering, Data Warehousing, Big Data Infrastructure and Tools)
  - **Domain Knowledge and Expertise** (Subject/Scientific domain related)
- EDISON identified 2 additional competence groups demanded by organisations
  - **Data Management, Data Governance, Stewardship, Curation, Preservation**
  - **Research Methods and/vs Business Processes/Operations**
- **Data Science professional skills:** Thinking and acting like Data Scientist – required to successfully develop as a Data Scientist and work in Data Science teams

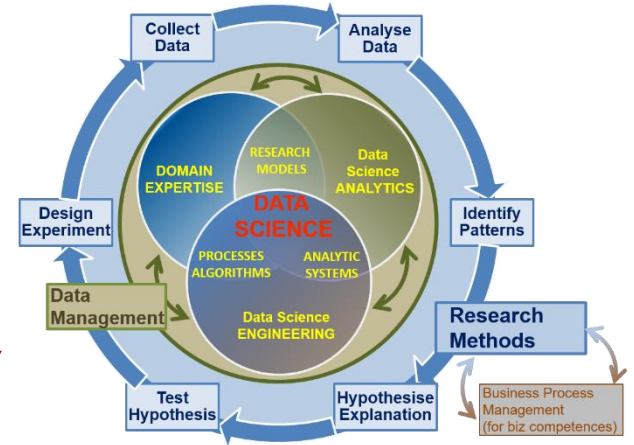



# Data Science Competence Groups - Research

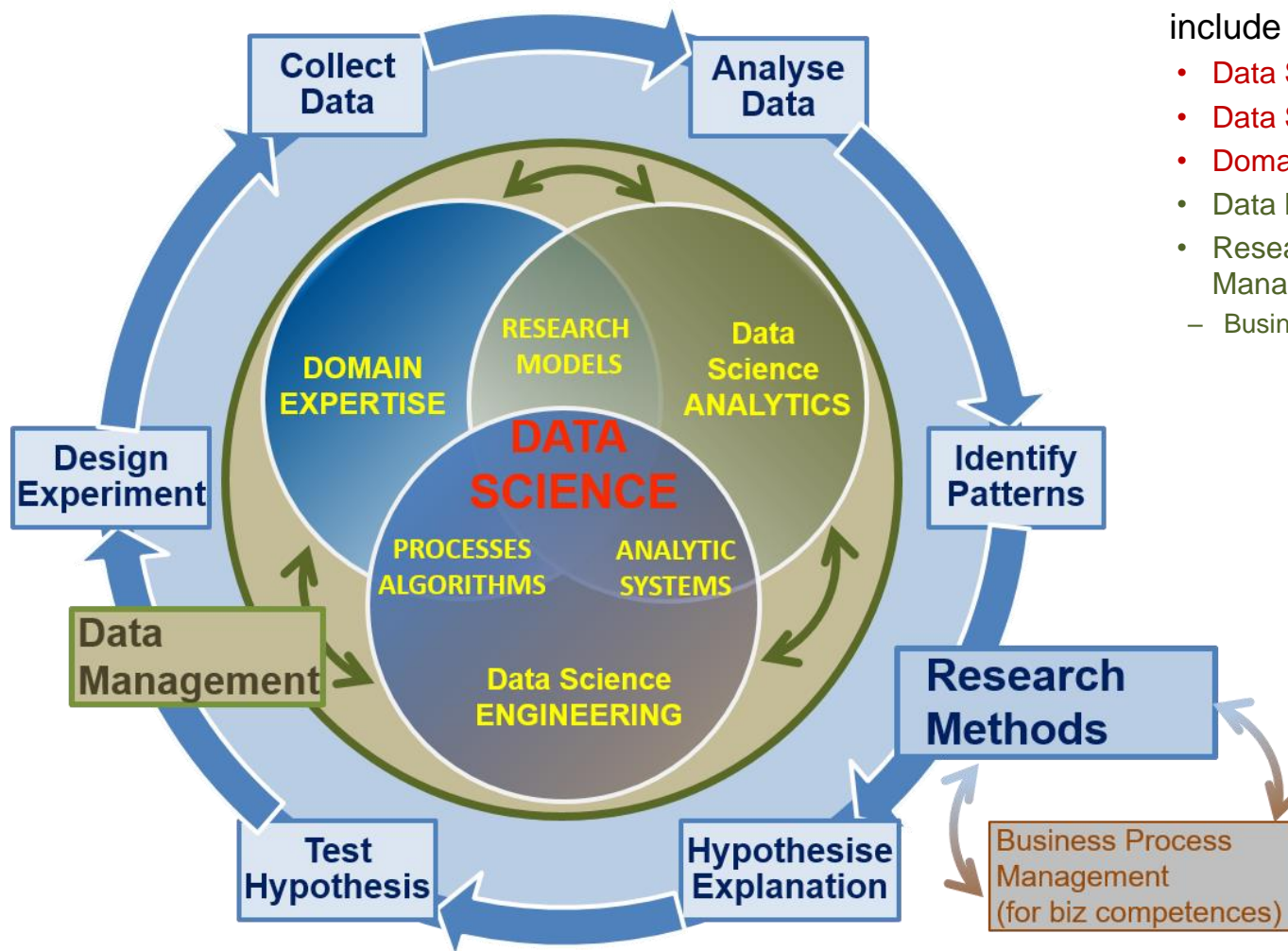

Data Science Competences include 5 groups

- Data Science Analytics
- Data Science Engineering
- Domain Knowledge and Expertise
- Data Management
- Research Methods and Project Management
  - Business Process Management (biz)

## Scientific Methods

- Design Experiment
- Collect Data
- Analyse Data
- Identify Patterns
- Hypothesis Explanation
- Test Hypothesis

## Business Operations

- Operations Strategy
- Plan
- Design & Deploy
- Monitor & Control
- Improve & Re-design

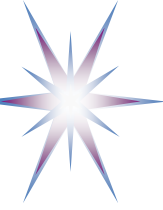

# Data Science Competences Groups – Business

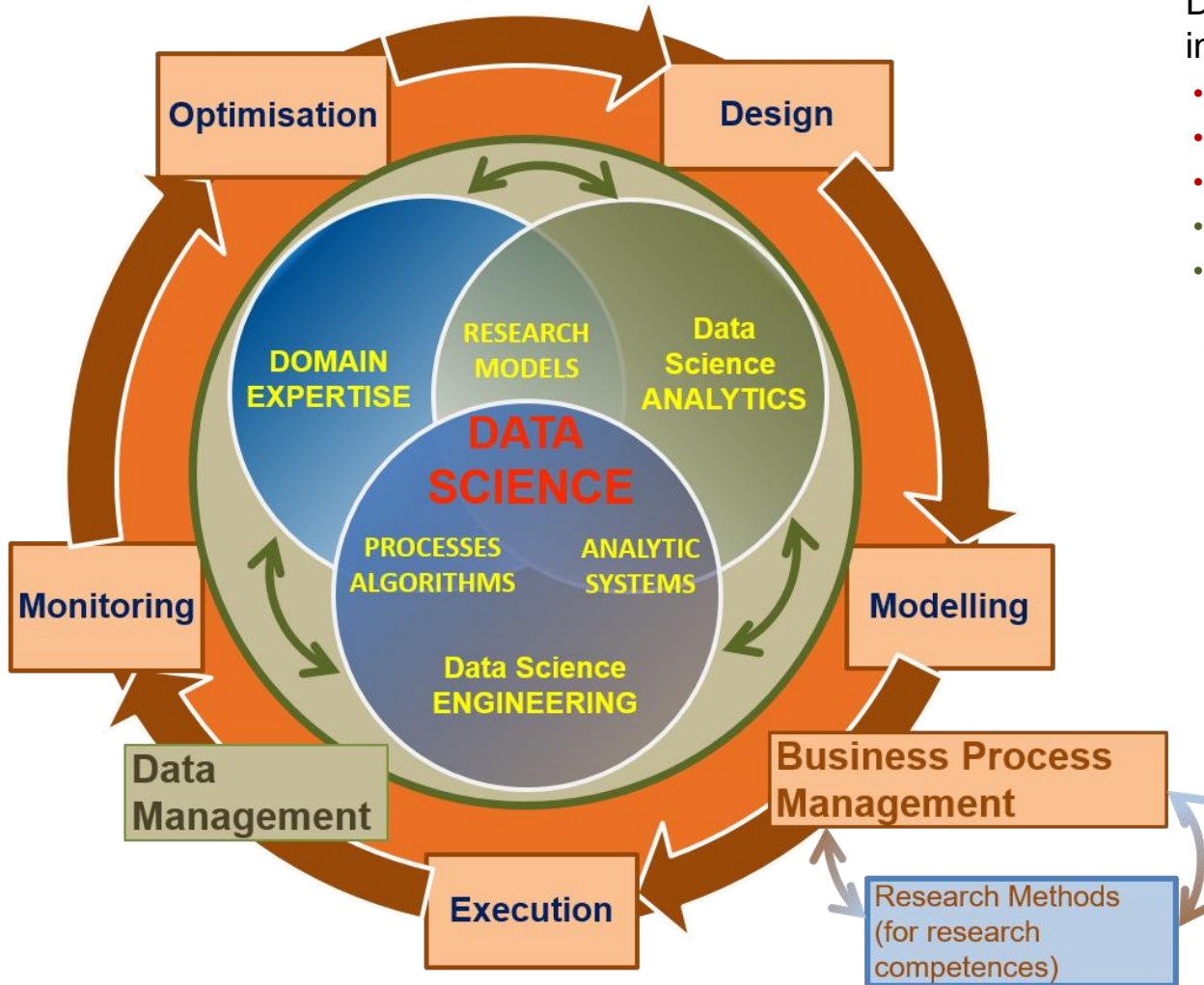

Data Science Competences include 5 groups

- Data Science Analytics
- Data Science Engineering
- Domain Knowledge and Expertise
- Data Management
- Research Methods and Project Management
- Business Process Management (biz)

## Scientific Methods

- Design Experiment
- Collect Data
- Analyse Data
- Identify Patterns
- Hypothesise Explanation
- Test Hypothesis

## Business Process Operations/Stages

- Design
- Model/Plan
- Deploy & Execute
- Monitor & Control
- Optimise & Re-design



# Identified Data Science Competence Groups

	Data Science Analytics (DSDA)	Data Science Engineering (DSENG)	Data Management and Governance (DSDM)	Research/Scientific Methods and Project Management (DSRMP)	Data Science Domain Knowledge, e.g. Business Analytics (DSDK/DSBPM)
0	Use appropriate data analytics and statistical techniques on available data to deliver insights into research problem or org. processes and support decision making	Use engineering principles and modern computer technology to research, design, implement new data analytics applications, develop experiments, processes, instruments, systems and infrastructures to support data handling during the whole data lifecycle	Develop and implement data management strategy for data collection, storage, preservation, and availability for further processing.	Create new understandings and capabilities by using the scientific method (hypothesis, test/artefact, evaluation) or similar engineering methods to discover new approaches to create new knowledge and achieve research or organisational goals	DSDK/DSBA Use domain knowledge (scientific or business) to develop relevant data analytics applications; adopt general Data Science methods to domain specific data types and presentations, data and process models, organisational roles and relations
1	<b>DSDA01</b> Effectively use variety of data analytics techniques	<b>DSENG01</b> Use engineering principles (general and software) to research, design, develop and implement new instruments and applications	<b>DSDM01</b> Develop and implement data strategy, in particular, Data Management Plan (DMP)	<b>DSRMP01</b> Create new understandings and capabilities by using scientific/ research methods	<b>DSBPM01</b> Understand business and provide insight, translate unstructured business problems into an abstract mathematical framework
2	<b>DSDA02</b> Apply designated quantitative techniques	<b>DSENG02</b> Develop and apply computer methods to domain related problems	<b>DSDM02</b> Develop data models including metadata	<b>DSRMP02</b> Direct systematic study toward a fuller knowledge or understanding of the observable facts	<b>DSBPM02</b> Participate strategically and tactically in financial decisions
3	<b>DSDA03</b> Pull together data from diff sources ...	<b>DSENG03</b> Develop and prototype data analytics applications	<b>DSDM03</b> Collect integrate data	<b>DSRMP03</b> Undertakes creative work	<b>DSBPM03</b> Provides support services to other
4	<b>DSDA04</b> Use diff perform techniques	<b>DSENG04</b> Develop, deploy operate Big Data storage	<b>DSDM04</b> Maintain repository	<b>DSRMP04</b> Translate strategies into actions	<b>DSBPM04</b> Analyse data for marketing
5	<b>DSDA05</b> Develop analytics applic	<b>DSENG05</b> Apply security mechanisms	<b>DSDM05</b> Visualise cmplx data	<b>DSRMP05</b> Contribute to organis goals	<b>DSBPM05</b> Analyse optimise customer relatio
6	<b>DSDA06</b> Visualise results of analysis, dashboards	<b>DSENG06</b> Design, build, operate SQL and NoSQL	<b>DSRM06</b> Develop and manage policies	<b>DSRMP06</b> Develop and guide data driven projects	<b>DSBPM06</b> Analyse data for marketing

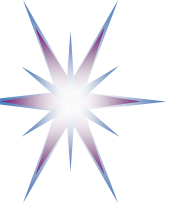

# Identified Data Science *Skills/Experience* Groups

## **Skills Type A – Based on knowledge acquired**

- **Group 1: Skills/experience related to competences**

- Data Analytics and Machine Learning
- Data Management/Curation (including both general data management and scientific data management)
- Data Science Engineering (hardware and software) skills
- Scientific/Research Methods or Business Process Management
- Application/subject domain related (research or business)

- **Group 2: Mathematics and statistics**

- Mathematics and Statistics and others

## **Skills Type B – Base on practical or workplace experience**

- **Group 3: Big Data (Data Science) tools and platforms**

- Big Data Analytics platforms
- Mathematics & Statistics applications & tools
- Databases (SQL and NoSQL)
- Data Management and Curation platform
- Data and applications visualisation
- **Cloud based platforms and tools**

- **Group 4: Data analytics programming languages and IDE**

- General and specialized development platforms for data analysis and statistics

- **Group 5: Soft skills and Workplace skills**

- Data Science professional skills: Thinking and Acting like Data Scientist
- 21st Century Skills: Personal, inter-personal communication, team work, professional network





# Group 5: Soft skills and Workplace skills

- Data Science professional skills: Thinking and Acting like Data Scientist
- 21st Century Skills: Personal, inter-personal communication, team work, professional network
- Data Scientist and Subject Domain Specialist

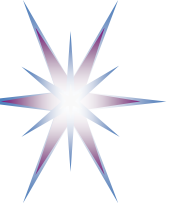

# Data Science Professional Skills: Thinking and Acting like Data Scientist

1. **Recognise value of data**, work with raw data, exercise good data intuition, use SN and open data
2. Accept (be ready for) **iterative development**, know when to stop, comfortable with failure, accept the symmetry of outcome (both positive and negative results are valuable)
3. Good **sense of metrics**, understand importance of the results validation, never stop looking at individual examples
4. **Ask the right questions**
5. **Respect domain/subject matter knowledge** in the area of data science
6. **Data driven problem solver** and **impact-driven mindset**
7. **Be aware about power and limitations** of the main machine learning and data analytics algorithms and tools
8. Understand that most of **data analytics algorithms are statistics and probability based**, so any answer or solution has some degree of probability and represent an optimal solution for a number variables and factors
9. Recognise what things are **important** and what things are **not important** (in data modeling)
10. Working in **agile environment** and coordinate with other roles and team members
11. Work in **multi-disciplinary team**, ability to communicate with the domain and subject matter experts
12. Embrace **online learning**, continuously improve your knowledge, use **professional networks** and communities
13. **Story Telling**: Deliver actionable result of your analysis
14. **Attitude**: Creativity, curiosity (willingness to challenge status quo), commitment in finding new knowledge and progress to completion
15. **Ethics and responsible use** of data and insight delivered, awareness of dependability (data scientist is a feedback loop in data driven companies)

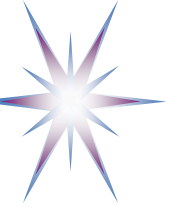

# Data Science Professional Skills: Thinking and Acting like Data Scientist (1)

1. **Recognise value of data**, work with raw data, exercise good data intuition, use SN and Open Data
2. Accept (be ready for) **iterative development**, know when to stop, comfortable with failure, accept the symmetry of outcome (both positive and negative results are valuable)
3. Good **sense of metrics**, understand importance of the results validation, never stop looking at individual examples
4. **Ask the right questions**
5. **Respect domain/subject matter knowledge** in the area of data science
6. **Data driven problem solver** and **impact-driven mindset**
7. **Be aware about power and limitations** of the main machine learning and data analytics algorithms and tools
8. Understand that most of **data analytics algorithms are statistics and probability based**, so any answer or solution has some degree of probability and represent an optimal solution for a number variables and factors

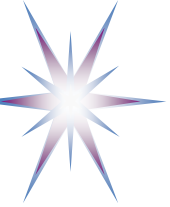

# Data Science Professional Skills: Thinking and Acting like Data Scientist (2)

9. Recognise what things are **important** and what things are **not important** (in data modeling)
10. Working in **agile environment** and coordinate with other roles and team members
11. Work in **multi-disciplinary team**, ability to communicate with the domain and subject matter experts
12. Embrace **online learning**, continuously improve your knowledge, use **professional networks** and communities
13. **Story Telling**: Deliver actionable result of your analysis
14. **Attitude**: Creativity, curiosity (willingness to challenge status quo), commitment in finding new knowledge and progress to completion
15. **Ethics and responsible use** of data and insight delivered, awareness of dependability (data scientist is a feedback loop in data driven companies)



# 21st Century Skills (DARE & BHEF & EDISON)

1. **Critical Thinking:** Demonstrating the ability to apply critical thinking skills to solve problems and make effective decisions
2. **Communication:** Understanding and communicating ideas
3. **Collaboration:** Working with other, appreciation of multicultural difference
4. **Creativity and Attitude:** Deliver high quality work and focus on final result, initiative, intellectual risk
5. **Planning & Organizing:** Planning and prioritizing work to manage time effectively and accomplish assigned tasks
6. **Business Fundamentals:** Having fundamental knowledge of the organization and the industry
7. **Customer Focus:** Actively look for ways to identify market demands and meet customer or client needs
8. **Working with Tools & Technology:** Selecting, using, and maintaining tools and technology to facilitate work activity
9. **Dynamic (self-) re-skilling:** Continuously monitor individual knowledge and skills as shared responsibility between employer and employee, ability to adopt to changes
10. **Professional networking:** Involvement and contribution to professional network activities
11. **Ethics:** Adhere to high ethical and professional norms, responsible use of power data driven technologies, avoid and disregard un-ethical use of technologies and biased data collection and presentation

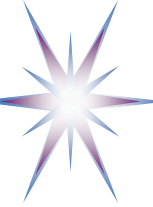

# Data Scientist and Subject Domain Specialist

- **Subject domain components**

- Model (and data types)
- Methods
- Processes
- Domain specific data and presentation/visualization methods
- Organisational roles and relations

- **Data Scientist is an assistant to Subject Domain Specialists**

- Translate subject domain Model, Methods, Processes into abstract data driven form
- Implement computational models in software, build required infrastructure and tools
- Do (computational) analytic work and present it in a form understandable to subject domain
- Discover new relations originated from data analysis and advice subject domain specialist
- Present/visualise information in domain related actionable way
- Interact and cooperate with different organizational roles to obtain data and deliver results and/or actionable data



# Data Science and Subject Domains

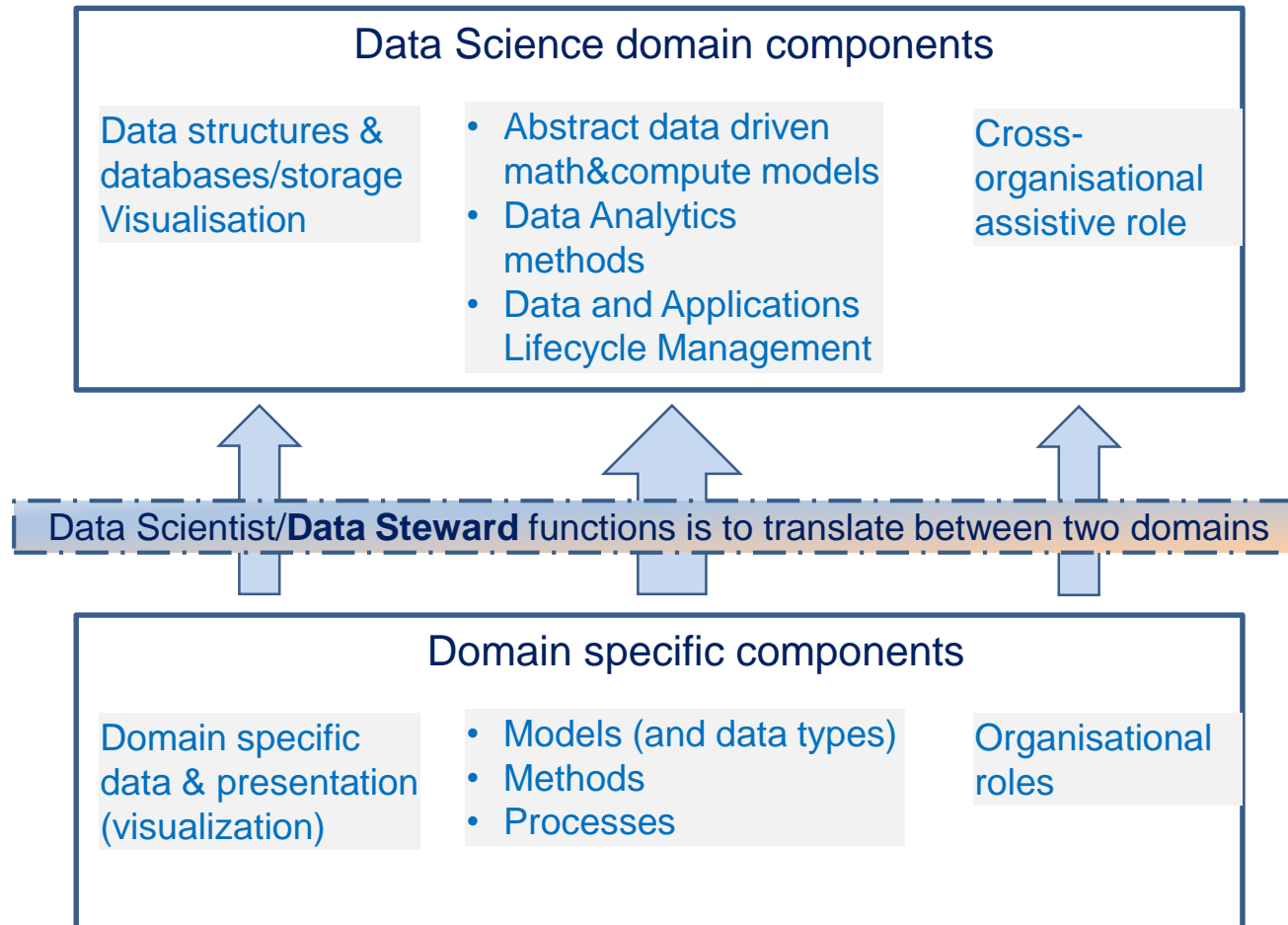

- Data Scientist role is to maintain the Data Value Chain (domain specific):**
- Data Integration => Organisation/Process/Business Optimisation => Innovation

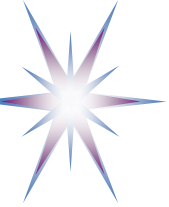

# Practical Application of the CF-DS

- Basis for the definition of the Data Science Body of Knowledge (DS-BoK) and Data Science Model Curriculum (MC-DS)
  - CF-DS => Learning Outcomes (MC-DS) => Knowledge Areas (DS-BoK)
  - CF-DS => Data Science taxonomy of scientific subjects and vocabulary
- Data Science professional profiles definition
  - Extend existing EU standards and occupations taxonomies: e-CFv3.0, ESCO, others
- Professional competence benchmarking
  - For customizable training and career development
  - Including CV or organisational profiles matching
- Professional certification
  - In combination with DS-BoK professional competences benchmarking
- Vacancy construction tool for job advertisement (for HR)
  - Using controlled vocabulary and Data Science Taxonomy



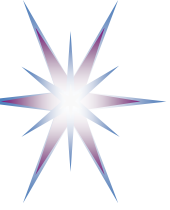

# CF-DS on the way to standardisation

- Contribution to e-CFv4.0
- Contribution to ICT Professional profiles

# Example Data Science Competences Definition Compliant with e-CFv3.0

			Dimension 1 Competence Group	DSDA	Data Science Analytics	
			Dimension 2 Competence	DSDA01	Effectively use variety of data analytics techniques, such as Machine Learning (including supervised, unsupervised, semi-supervised learning), Data Mining, Prescriptive and Predictive Analytics, for complex data analysis through the whole data lifecycle	
			Dimension 3 Proficiency level	Level 1 (Entry/Associate)	Level 1 (Professional)	Level 1 (Expert)
Dimension 1 Competence Group	DSDA	Data Science Analytics		Understand and be able to select an approach to analyzing datasets.	Apply designated quantitative techniques, including statistics, time series analysis, optimization, and simulation to deploy appropriate models for analysis and prediction	Develop and plan required data analytics for organizational tasks, including: evaluating requirements and specifications of problems to recommend possible analytics-based solutions
Dimension 2 Competence	DSDA04	Understand and use different performance and accuracy metrics for model validation in analytics projects, hypothesis testing, and information retrieval		Understand and use different performance and accuracy metrics for model validation in analytics projects, hypothesis testing, and information retrieval		
Dimension 3 Proficiency level			Level 1 (Entry/Associate) Be familiar and be able to use different performance and accuracy metrics as part of used data analytics platforms	Level 1 (Professional) Select appropriate performance metrics and apply them for specific analytics applications. Develop new metrics and use it for fine tuning the used analytics solutions.	Level 1 (Expert) Not specifically defined. Advanced knowledge and experience.	
Dimension 4 Knowledge	Knowledge ID	Knowledge unit definition				
	KDSDA01	Machine Learning (supervised): Decision trees, Naïve Bayes classification, Ordinary least square regression, Logistic regression, Neural Networks, SVM (Support Vector Machine), Ensemble methods, others				
	KDSDA02	Machine Learning (unsupervised): clustering algorithms, Principal Components Analysis (PCA), Singular Value Decomposition (SVD), Independent Components Analysis (ICA)				
	KDSDA06	Predictive Analytics				
	KDSDA11	Performance and accuracy metrics				
	KDSDA14	Optimisation				
	Skill ID	Skills definition				
Skills Data Analytics methods and algorithms	SDSDA01	Use Machine Learning technology, algorithms, tools (including supervised, unsupervised, or reinforced learning)				
	SDSDA04	Apply Predictive Analytics methods				
	SDSDA09	Be able to use performance and accuracy metrics for data analytics assessment and validation				
Skills Data Analytics languages, tools and platforms	DSALANG01	R and data analytics libraries (cran, ggplot2, dplyr, reshape2, etc.)				
	DSALANG02	Python and data analytics libraries (pandas, numpy, matplotlib, scipy, scikit-learn, seaborn, etc.)				
	DSABDA02	Big Data Analytics platforms (Hadoop, Spark, Data Lakes, others)				
	DSABDA09	Kaggle competition, resources and community platform				
						<p>Knowledge unit definition</p> <p>Machine Learning (supervised): Decision trees, Naïve Bayes classification, Ordinary least square regression, Logistic regression, Neural Networks, SVM (Support Vector Machine), Ensemble methods, others</p> <p>Machine Learning (unsupervised): clustering algorithms, Principal Components Analysis (PCA), Singular Value Decomposition (SVD), Independent Components Analysis (ICA)</p> <p>Machine Learning (reinforced): Q-Learning, TD-Learning, Genetic Algorithms)</p> <p>Data Mining (Text mining, Anomaly detection, regression, time series, classification, feature selection, association, clustering)</p> <p>Predictive Analytics</p> <p>Prescriptive Analytics</p> <p>Data preparation and pre-processing</p> <p>Performance and accuracy metrics</p> <p>Skills definition</p> <p>Use Machine Learning technology, algorithms, tools (including supervised, unsupervised, or reinforced learning)</p> <p>Use Data Mining techniques</p> <p>Apply Predictive Analytics methods</p> <p>Apply Prescriptive Analytics methods</p> <p>Use Graph Data Analytics for organisational network analysis, customer relations, other tasks</p> <p>R and data analytics libraries (cran, ggplot2, dplyr, reshape2, etc.)</p> <p>Python and data analytics libraries (pandas, numpy, matplotlib, scipy, scikit-learn, seaborn, etc.)</p> <p>SQL and relational databases (open source: PostgreSQL, MySQL, Nettezza, etc.)</p> <p>NoSQL Databases (Hbase, MongoDB, Cassandra, Redis, Accumulo, etc.)</p> <p>Visualisation software (D3.js, Processing, Tableau, Raphael, Gephi, etc.)</p> <p>Big Data Analytics platforms (Hadoop, Spark, Data Lakes, others)</p> <p>Real time and streaming analytics systems (Flume, Kafka, Storm)</p> <p>Kaggle competition, resources and community platform</p> <p>Git versioning system as a general platform for software development</p>



# Defining Data Science Professional Profiles

---

- CWA 16458 (2012): European ICT Professional Profiles
- ESCO (2017): European, Skills, Competences, Occupations

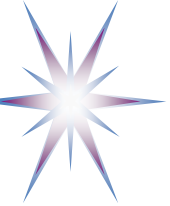

# CWA 16458 (2012): European ICT Professional Profiles

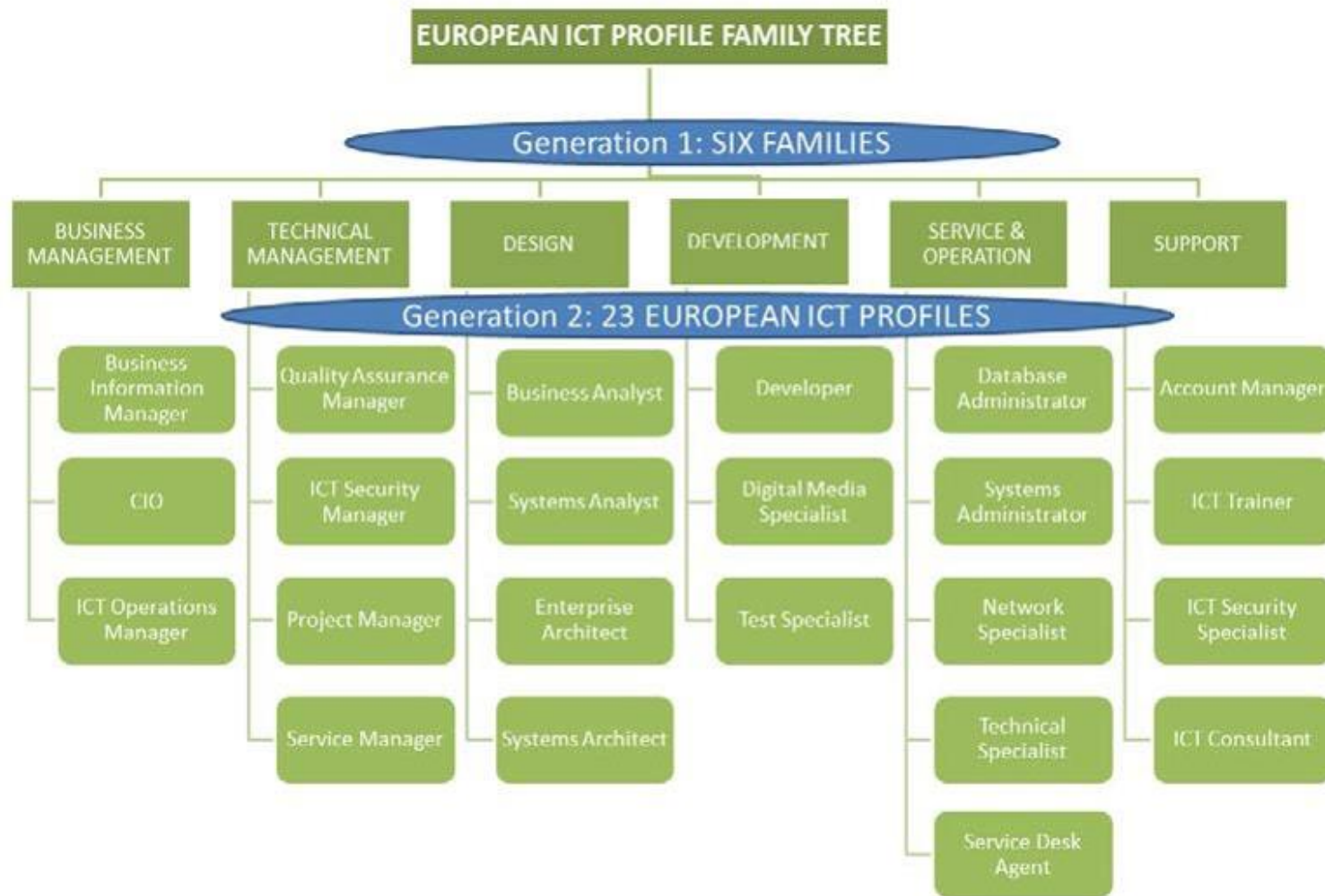

- The CWA defines 23 main ICT profiles the most widely used by organisations

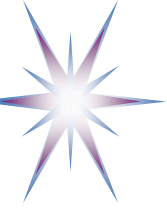

# CWA Professional Profiles and Organisational Workflow

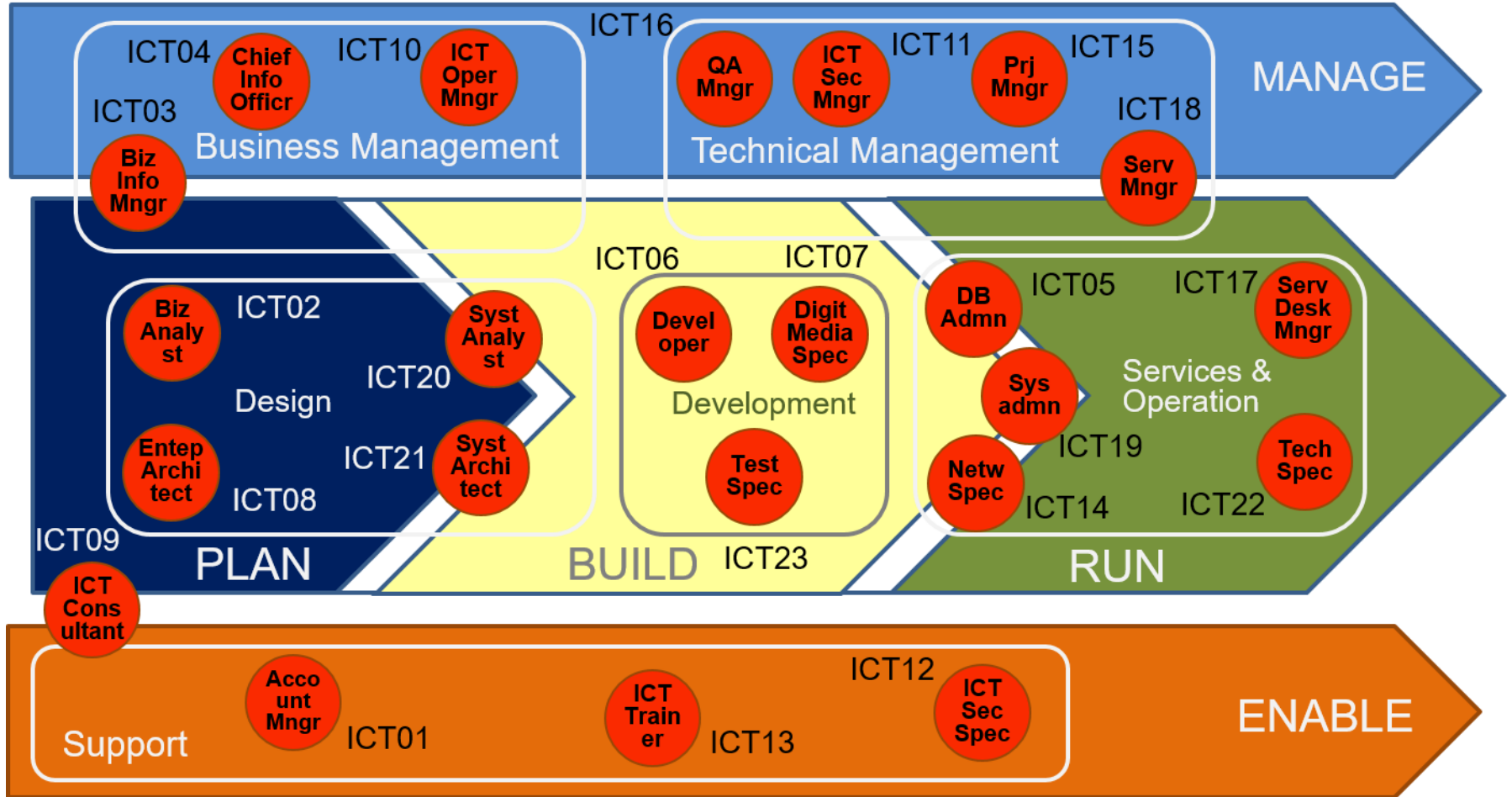

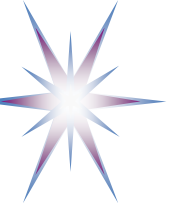

# Data Science Professions Family

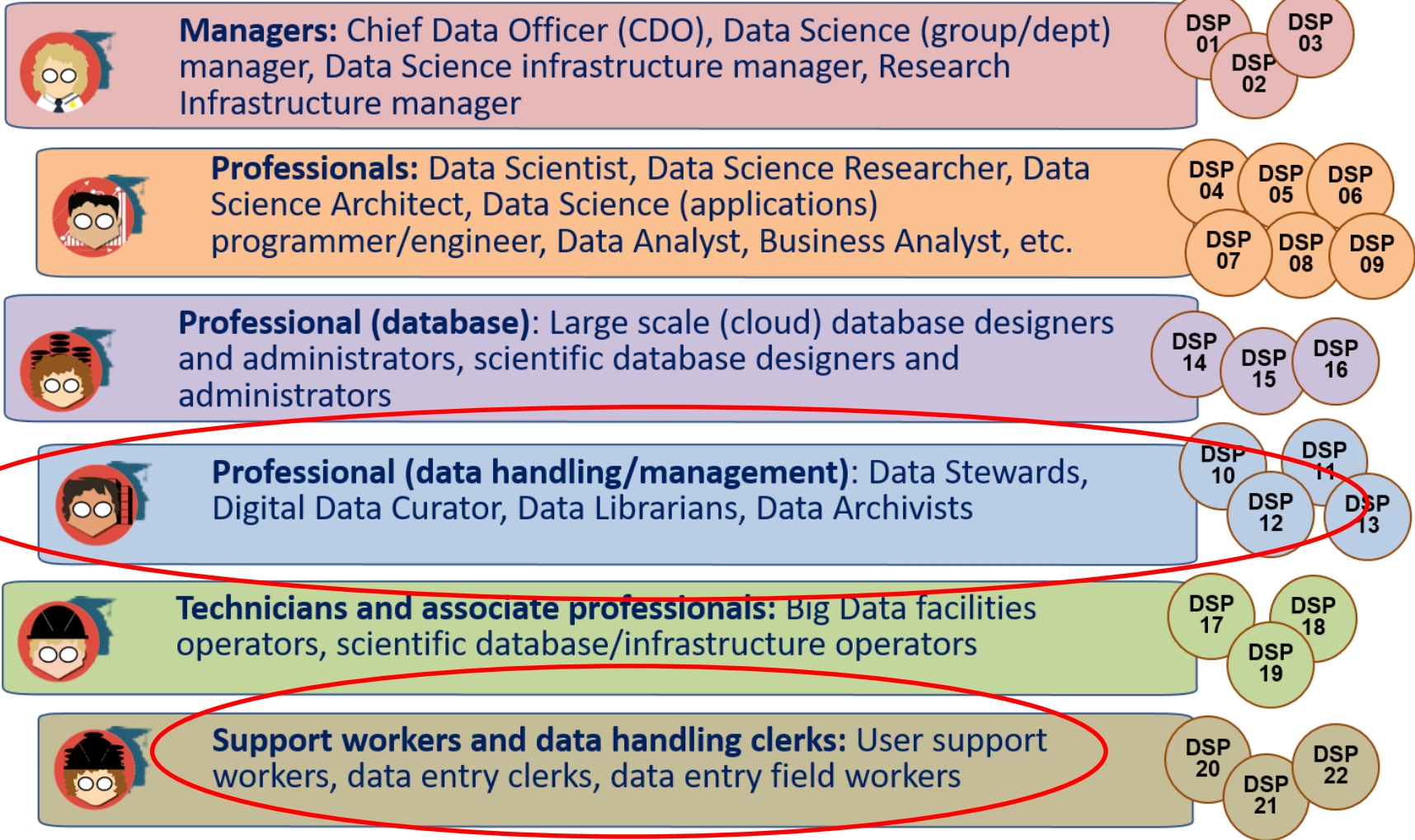

Icons used: Credit to [ref] <https://www.datacamp.com/community/tutorials/data-science-industry-infographic>

# DSP Profiles mapping to ESCO Taxonomy High Level Groups

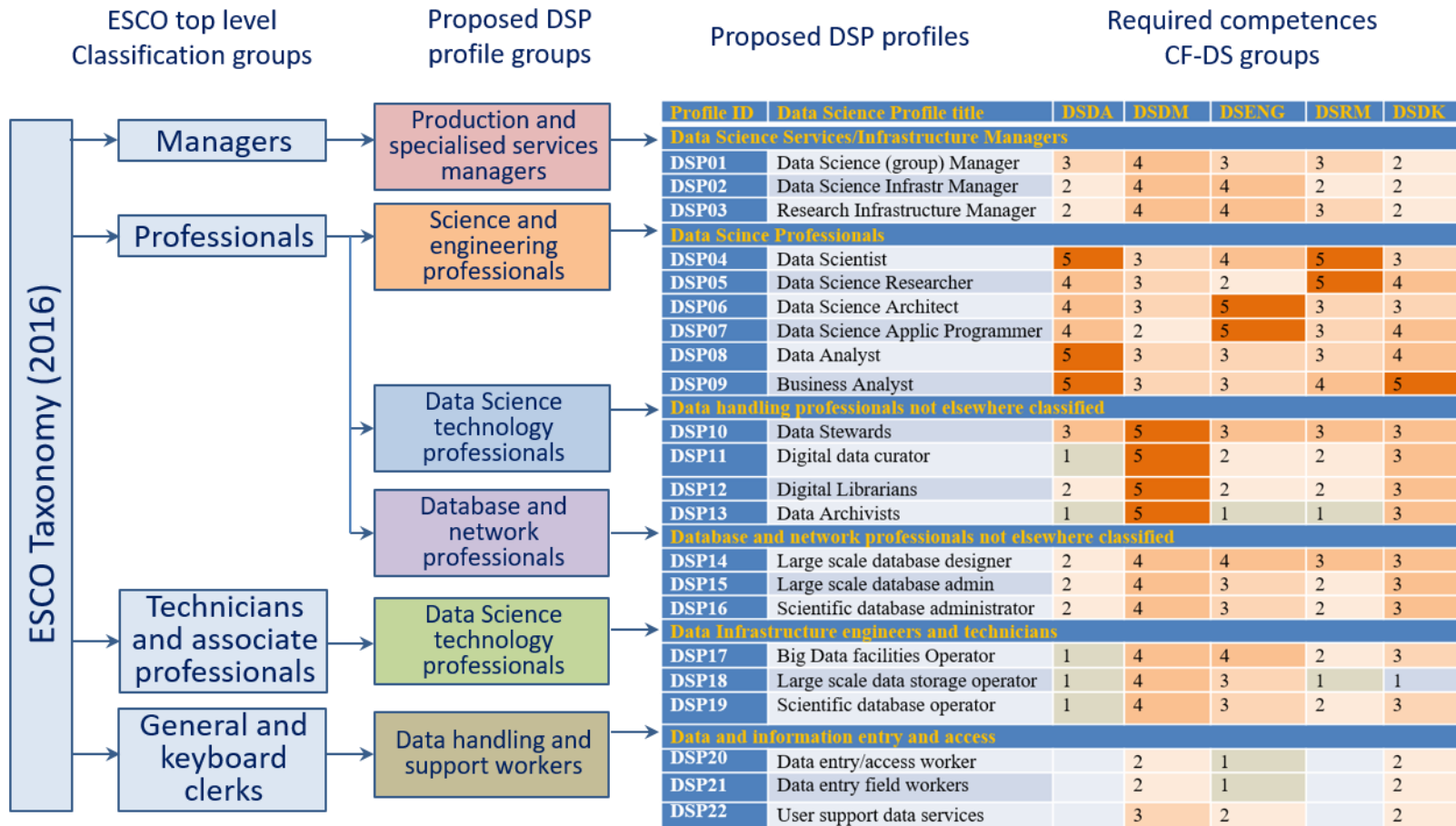

- DSP Profiles mapping to corresponding CF-DS Competence Groups
  - Relevance level from 5 – maximum to 1 – minimum

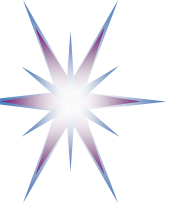

# CF-DS and Data Science Professional Profiles

Whole range of DSA enabled Domain related Profiles

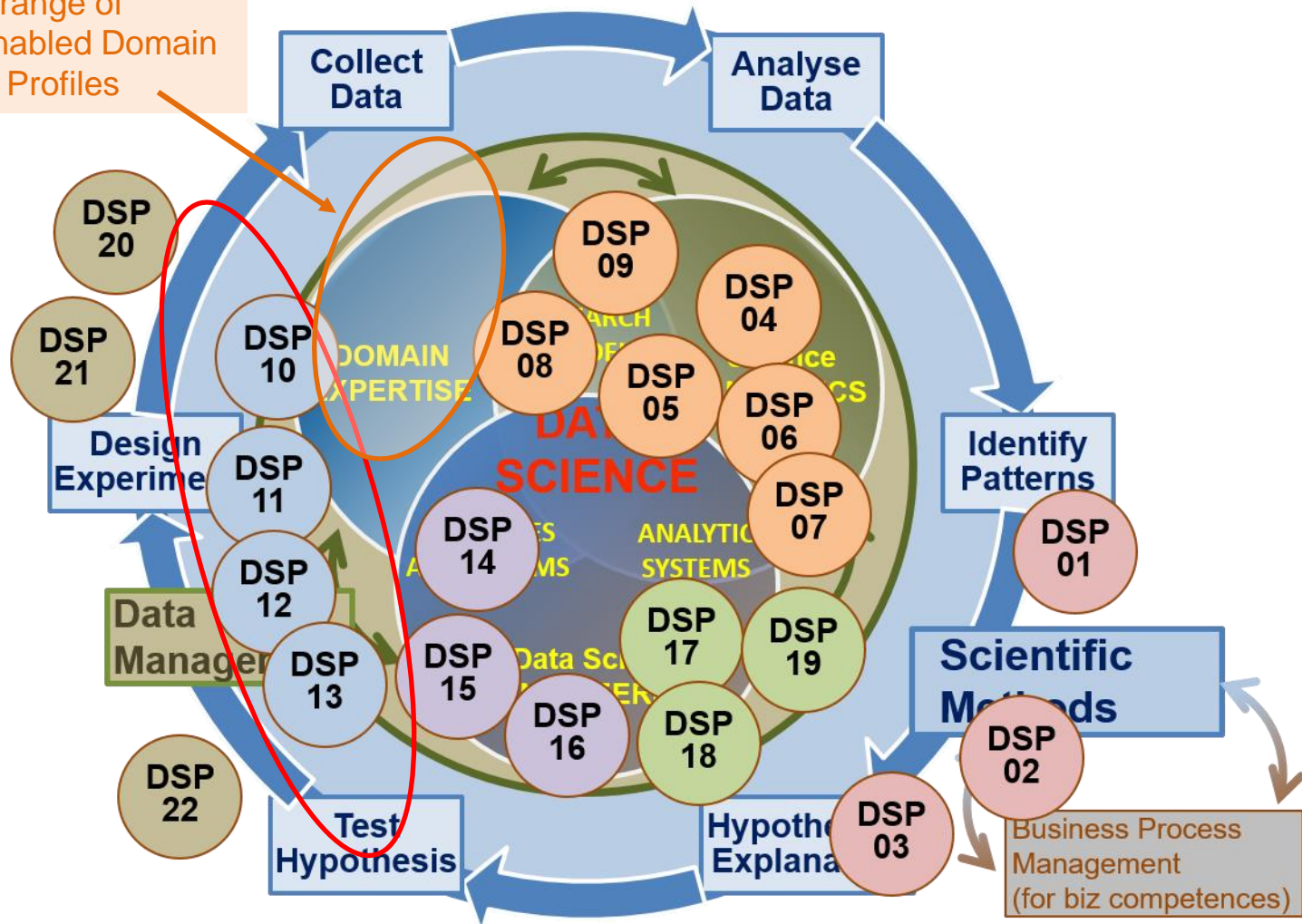



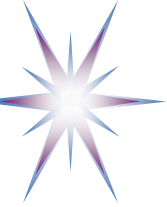

# Template DS Professional Profile Definition (compliant with CWA)

<b>Profile title</b>	Gives a commonly used name to a profile. <b>TEMPLATE</b>		
<b>Summary statement</b>	<p>Indicates the main purpose of the profile.</p> <p>The purpose is to present to stakeholders and users a brief, concise understanding of the specified ICT Profile. It should be understandable by ICT professionals, ICT managers and Human Resource personnel. It should provide a statement of the job's main activity.</p>		
<b>Mission</b>	<p>Describes the rationale of the profile.</p> <p>The purpose is to specify the designated job role defined in the ICT Profile.</p>		
<b>Deliverables</b>	Accountable (A)	Responsible (R)	Contributor (C)
	<p>Specifies the Profile by key deliverables.</p> <p>The purpose is to illuminate the ICT Profiles and to explain relevance including the perspective from a non-ICT point of view.</p>		
<b>Main task/s</b>	<p>Provides a list of typical tasks to be performed by the profile.</p> <p>A task is an action taken to achieve a result within a broadly defined context. Tasks may be associated with deadlines, resources, goals, specifications and/or the expected results.</p>		
<b>e-CF competences assigned</b>	<p>Provides a list of necessary competences (from the e-CF) to carry out the mission.</p> <p>Must include 1 up to 5 competences.</p> <p>Level assignment is important. Can be (usually) 1 or (maximum) 2 levels.</p>		
<b>KPI Area</b>	<p>Based upon KPIs (Key Performance Indicators) KPI area is a more generic indicator, congruent with the overall profile granularity level. It is deployed to add depth to the mission.</p> <p>Not prescriptive. Non-specific measurements. Use general examples.</p> <p>The principle is to provide KPI areas (which are stable, general and long lasting) providing users with an inspiration to enable development of specific KPI's for specific roles</p> <p>Must be related to the key deliverables in order to measure them.</p>		



# EDSF for Education and Training

- Foundation and methodological base
  - Data Science Body of Knowledge (DS-BoK)
    - Taxonomy and classification of Data Science related scientific subjects
  - Data Science Model Curriculum (MC-DS)
    - Set Learning Units mapped to CF-DS Learning Outcomes and DS-BoK Knowledge Areas/Units
  - Instructional methodologies and teaching models
- Platforms and environment
  - Virtual labs, datasets, developments platforms
  - Online education environment and courses management
- Services
  - Individual benchmarking and profiling tools (competence assessment)
  - Knowledge evaluation tools
  - Certifications and training for self-made Data Scientists practitioners
  - Education and training marketplace: Courses catalog and repository

# Data Science Body of Knowledge (DS-BoK)

## DS-BoK Knowledge Area Groups (KAG)

- KAG1-DNA: Data Analytics group including Machine Learning, statistical methods, and Business Analytics
- KAG2-DSE: Data Science Engineering group including Software and infrastructure engineering
- **KAG3-DSDM: *Data Management group including data curation, preservation and data infrastructure***
- **KAG4-DSRM: *Research Methods and Project Management group***
- KAG5-DSBA: Business Analytics and Business Intelligence
- KAG\* - DSDK: Data Science domain knowledge to be defined by related expert groups

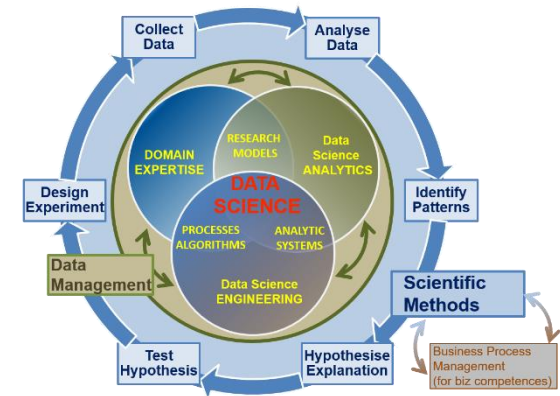



# Data Science Body of Knowledge (1)

KA Groups	Suggested DS Knowledge Areas (KA)	Knowledge Areas from existing BoK and CCS2012 scientific subject groups
KAG1-DSDA: Data Science Analytics	KA01.01 (DSDA.01/SMDA) Statistical methods for data analysis KA01.02 (DSDA.02/ML) Machine Learning KA01.03 (DSDA.03/DM) Data Mining KA01.04 (DSDA.04/TDM) Text Data Mining KA01.05 (DSDA.05/PA) Predictive Analytics KA01.06 (DSDA.06/MODSIM) Computational modelling, simulation and optimisation	<p>There is no formal BoK defined for Data Analytics.</p> <p>Data Science Analytics related scientific subjects from CCS2012: CCS2012: Computing methodologies CCS2012: Mathematics of computing CCS2012: Computing methodologies</p>
KAG2-DSENG: Data Science Engineering	KA02.01 (DSENG.01/BDI) Big Data Infrastructure and Technologies KA02.02 (DSENG.02/DSIAPP) Infrastructure and platforms for Data Science applications KA02.03 (DSENG.03/CCT) Cloud Computing technologies for Big Data and Data Analytics KA02.04 (DSENG.04/SEC) Data and Applications security KA02.05 (DSENG.05/BDSE) Big Data systems organisation and engineering KA02.06 (DSENG.06/DSAPPD) Data Science (Big Data) applications design KA02.07 (DSENG.07/IS) Information systems (to support data driven decision making)	<p>ACM CS-BoK selected KAs: AR - Architecture and Organization (including computer architectures and network architectures) CN - Computational Science IM - Information Management SE - Software Engineering (can be extended with specific SWEBOK KAs)</p> <p>SWEBOK selected KAs</p> <ul style="list-style-type: none"><li>• Software requirements</li><li>• Software design</li><li>• Software engineering process</li><li>• Software engineering models and methods</li><li>• Software quality</li></ul> <p>Data Science Analytics related scientific subjects from CCS2012</p>

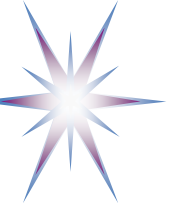

# Data Science Body of Knowledge (2)

KA Groups	Suggested DS Knowledge Areas (KA)	Knowledge Areas from existing BoK and CCS2012 scientific subject groups
KAG3-DSDM: Data Management	KA03.01 (DSDM.01/DMORG) General principles and concepts in Data Management and organisation KA03.02 (DSDM.02/DMS) Data management systems KA03.03 (DSDM.03/EDMI) Data Management and Enterprise data infrastructure KA03.04 (DSDM.04/DGOV) Data Governance KA03.05 (DSDM.05/BDSTOR) Big Data storage (large scale) KA03.06 (DSDM.05/DLIB) Digital libraries and archives	DM-BoK selected KAs (1) Data Governance, (2) Data Architecture, (3) Data Modelling and Design, (4) Data Storage and Operations, (5) Data Security, (6) Data Integration and Interoperability, (7) Documents and Content, (8) Reference and Master Data, (9) Data Warehousing and Business Intelligence, (10) Metadata, and (11) Data Quality.
KAG4-DSRM: Research Methods and Project Management	KA04.01 (DSRMP.01/RM) Research Methods KA04.01 (DSRMP.02/PM) Project Management	There are no formally defined BoK for research methods PMI-BoK selected KAs <ul style="list-style-type: none"> <li>• Project Integration Management</li> <li>• Project Scope Management</li> <li>• Project Quality</li> <li>• Project Risk Management</li> </ul>
KAG5-DSBPM: Business Analytics	KA05.01 (DSBA.01/BAF) Business Analytics Foundation KA05.02 (DSBA.02/BAEM) Business Analytics organisation and enterprise management	BABOK selected KAs *) Business Analysis Planning and Monitoring Requirements Life Cycle Management Solution Evaluation and improvements recommendation

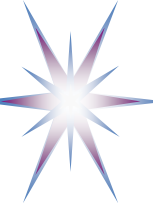

# Data Science Model Curriculum (MC-DS)

## Data Science Model Curriculum includes

- Learning Outcomes (LO) definition based on CF-DS
  - LOs are defined for CF-DS competence groups and for all enumerated competences
  - Knowledge levels: Familiarity, Usage, Assessment (based in Bloom's Taxonomy)
- LOs mapping to Learning Units (LU)
  - LUs are based on CCS(2012) and universities best practices
  - Data Science university programmes and courses inventory (interactive)  
<http://edison-project.eu/university-programs-list>
- LU/course relevance: Mandatory Tier 1, Tier 2, Elective, Prerequisite
- Learning methods and learning models (in progress)

# Learning methods and learning models

- Bloom's Taxonomy and Cognitive learning activities
  - BT application areas and limitations
- Constructive Alignment and Intended Learning Outcome (ILO)
  - ILO is formulated from the student perspective
  - Outcome Based Learning (OBL)
- Other education technologies for teaching in fast technology changing world
  - Project Based Learning (PBL)
  - Flipped classroom
  - Activating teaching and activating strategies

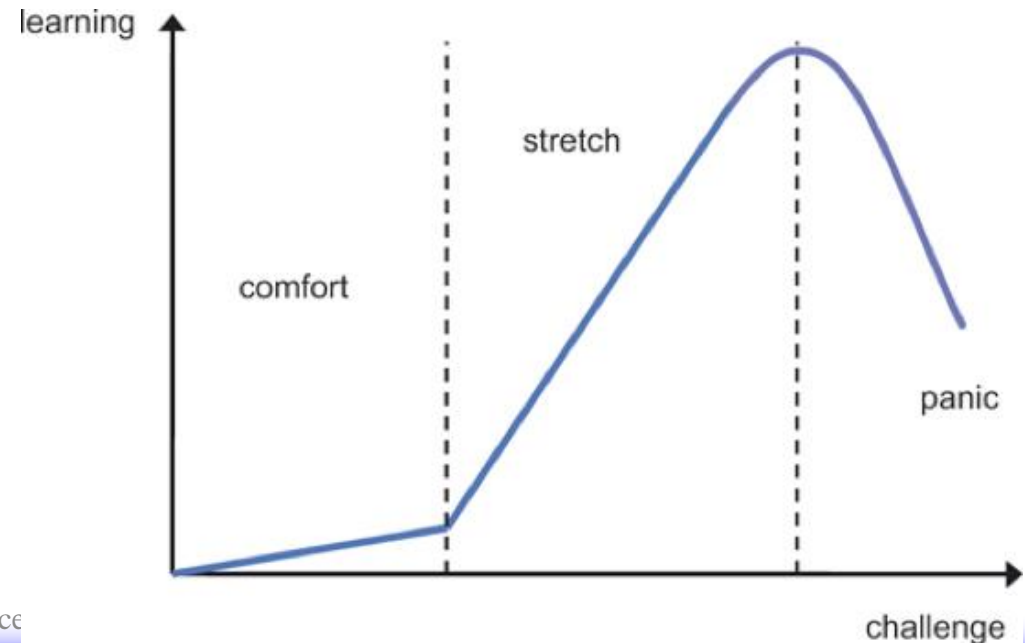

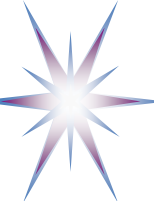

# Bloom's Taxonomy and Knowledge Levels for MC-DS

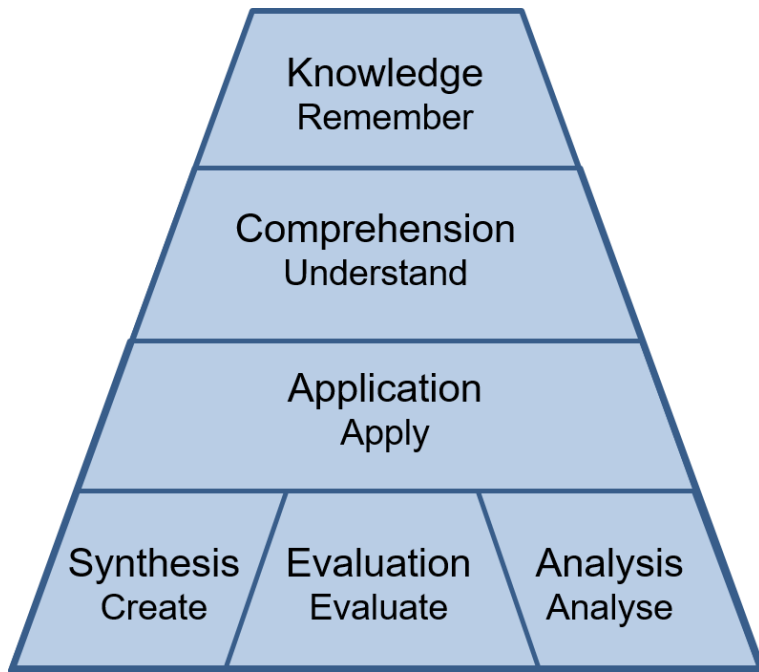

Level	Action Verbs
Familiarity	Choose, Classify, Collect, Compare, Configure, Contrast, Define, Demonstrate, Describe, Execute, Explain, Find, Identify, Illustrate, Label, List, Match, Name, Omit, Operate, Outline, Recall, Rephrase, Show, Summarize, Tell, Translate
Usage	Apply, Analyze, Build, Construct, Develop, Examine, Experiment with, Identify, Infer, Inspect, Model, Motivate, Organize, Select, Simplify, Solve, Survey, Test for, Visualize
Assessment	Adapt, Assess, Change, Combine, Compile, Compose, Conclude, Criticize, Create, Decide, Deduct, Defend, Design, Discuss, Determine, Disprove, Evaluate, Imagine, Improve, Influence, Invent, Judge, Justify, Optimize, Plan, Predict, Prioritize, Prove, Rate, Recommend, Solve



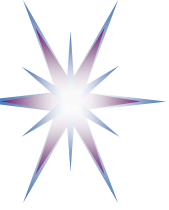

# Extended Bloom's Taxonomy

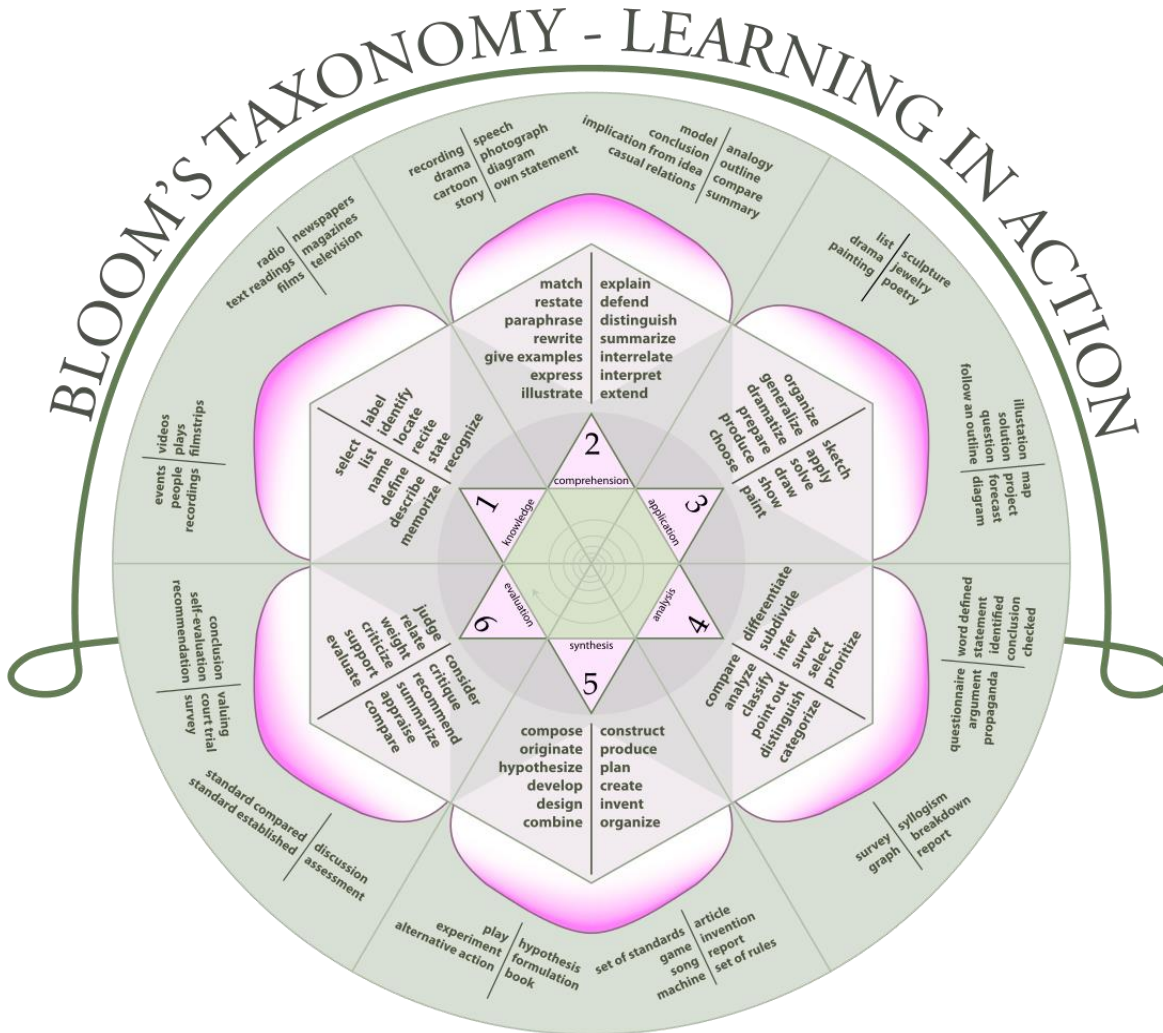

Consolidated presentation of learning levels, action verbs, and **associated learning instruments**

[ref] Anderson, L. W., & Krathwohl, D. R. (2001). A taxonomy for learning, teaching, and assessing, Abridged Edition. Boston, MA: Allyn and Bacon.

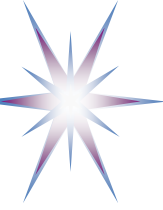

# Bloom's Taxonomy – Cognitive Activities

## Knowledge

Exhibit memory of previously learned materials by recalling facts, terms, basic concepts and answers

- Knowledge of specifics - terminology, specific facts
- Knowledge of ways and means of dealing with specifics - conventions, trends and sequences, classifications and categories, criteria, methodology
- Knowledge of the universals and abstractions in a field - principles and generalizations, theories and structures
- **Questions like: What are the main benefits of implementing Big Data and data analytics methods for organisation?**

## Comprehension

Demonstrate understanding of facts and ideas by organizing, comparing, translating, interpreting, describing, and stating the main ideas

- Translation, Interpretation, Extrapolation
- **Questions like: Compare the business and operational models of private clouds and hybrid clouds.**

## Application

Using new knowledge. Solve problems in new situations by applying acquired knowledge, facts, techniques and rules in a different way

- **Questions like: What data analytics methods should be applied for specific data types analysis or for specific business processes and activities? Which Big Data services architecture is best suited for medium size research organisation or company, and why??**

## Analysis

Examine and break information into parts by identifying motives or causes. Make inferences and find evidence to support generalizations

- Analysis of elements, relationships, organizational principles
- **Questions like: What data analytics methods and services are required to support typical business processes of a web trading company? Give suggestions how these services can be implemented with the selected data analytics platform, including on-premises or outsourced to cloud. Provide references to support your statements.**

## Synthesis

Compile information together in a different way by combining elements in a new pattern or proposing alternative solutions

- Production of a unique communication, a plan, or proposed set of operations, derivation of a set of abstract relations
- **Questions like: Describe the main steps and tasks for implementing data analytics and data management services for an example company or research organisation? What services and data analytics can be moved to clouds and which will remain at the enterprise premises and run by company's personnel?**

## Evaluation

Present and defend opinions by making judgments about information, validity of ideas or quality of work based on a set of criteria

- Judgments in terms of internal evidence or external criteria
- **Questions like: Do you think that implementing Agile Data Driven Enterprise model creates benefits for enterprises, short term and long term?**



# EDSF-MC Knowledge levels for Learning Outcomes (defined based on Bloom's Taxonomy)

Level	Action Verbs
Familiarity	Choose, Classify, Collect, Compare, Configure, Contrast, Define, Demonstrate, Describe, Execute, Explain, Find, Identify, Illustrate, Label, List, Match, Name, Omit, Operate, Outline, Recall, Rephrase, Show, Summarize, Tell, Translate
Usage	Apply, Analyze, Build, Construct, Develop, Examine, Experiment with, Identify, Infer, Inspect, Model, Motivate, Organize, Select, Simplify, Solve, Survey, Test for, Visualize
Assessment	Adapt, Assess, Change, Combine, Compile, Compose, Conclude, Criticize, Create, Decide, Deduct, Defend, Design, Discuss, Determine, Disprove, Evaluate, Imagine, Improve, Influence, Invent, Judge, Justify, Optimize, Plan, Predict, Prioritize, Prove, Rate, Recommend, Solve



# Data Science Data Analytics (KAG1 – DSDA) related courses

- KA01.01 (DSDA/SMDA) Statistical methods, including Descriptive statistics, exploratory data analysis (EDA) focused on discovering new features in the data, and confirmatory data analysis (CDA) dealing with validating formulated hypotheses;
- KA01.02 (DSDA/ML) Machine learning and related methods for information search, image recognition, decision support, classification;
- KA01.03 (DSDA/DM) Data mining is a particular data analysis technique that focuses on modelling and knowledge discovery for predictive rather than purely descriptive purposes;
- KA01.04 (DSDA/TDM) Text analytics applies statistical, linguistic, and structural techniques to extract and classify information from textual sources, a species of unstructured data;
- KA01.05 (DSDA/PA) Predictive analytics focuses on application of statistical models for predictive forecasting or classification;
- KA01.06 (DSDA/MODSIM) Computational modelling, simulation and optimisation.

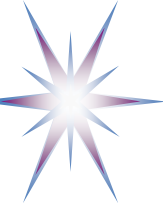

# Data Science Engineering (KAG2-DSENG)

- KA02.01 (DSENG/BDI) Big Data infrastructure and technologies, including NOSQL databased, platforms for Big Data deployment and technologies for large-scale storage;
- KA02.02 (DSENG/DSIAPP) Infrastructure and platforms for Data Science applications, including typical frameworks such as Spark and Hadoop, data processing models and consideration of common data inputs at scale;
- KA02.03 (DSENG/CCT) Cloud Computing technologies for Big Data and Data Analytics;
- KA02.04 (DSENG/SEC) Data and Applications security, accountability, certification, and compliance;
- KA02.05 (DSENG/BDSE) Big Data systems organization and engineering, including approached to big data analysis and common MapReduce algorithms;
- KA02.06 (DSENG/DSAPPD) Data Science (Big Data) application design, including languages for big data (Python, R), tools and models for data presentation and visualization;
- KA02.07 (DSENG/IS) Information Systems, to support data-driven decision making, with focus on data warehouse and data centers.

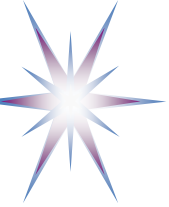

# KAG3-DSDM: *Data Management group: data curation, preservation and data infrastructure*

DM-BoK version 2 “Guide for performing data management”

– 11 Knowledge Areas

- (1) Data Governance
- (2) Data Architecture
- (3) Data Modelling and Design
- (4) Data Storage and Operations
- (5) *Data Security***
- (6) Data Integration and Interoperability
- (7) *Documents and Content***
- (8) Reference and Master Data
- (9) Data Warehousing and Business Intelligence
- (10) *Metadata***
- (11) Data Quality

Other Knowledge Areas motivated by RDA, European Open Data initiatives, European Open Data Cloud

- (12) *PID, metadata, data registries***
- (13) *Data Management Plan***
- (14) *Open Science, Open Data, Open Access, ORCID***
- (15) *Responsible data use***

- Highlighted in red: Considered (Research) Data Management literacy (minimum required knowledge)

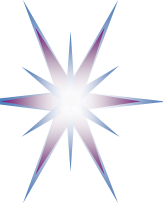

# Outcome Based Educations and Training Model

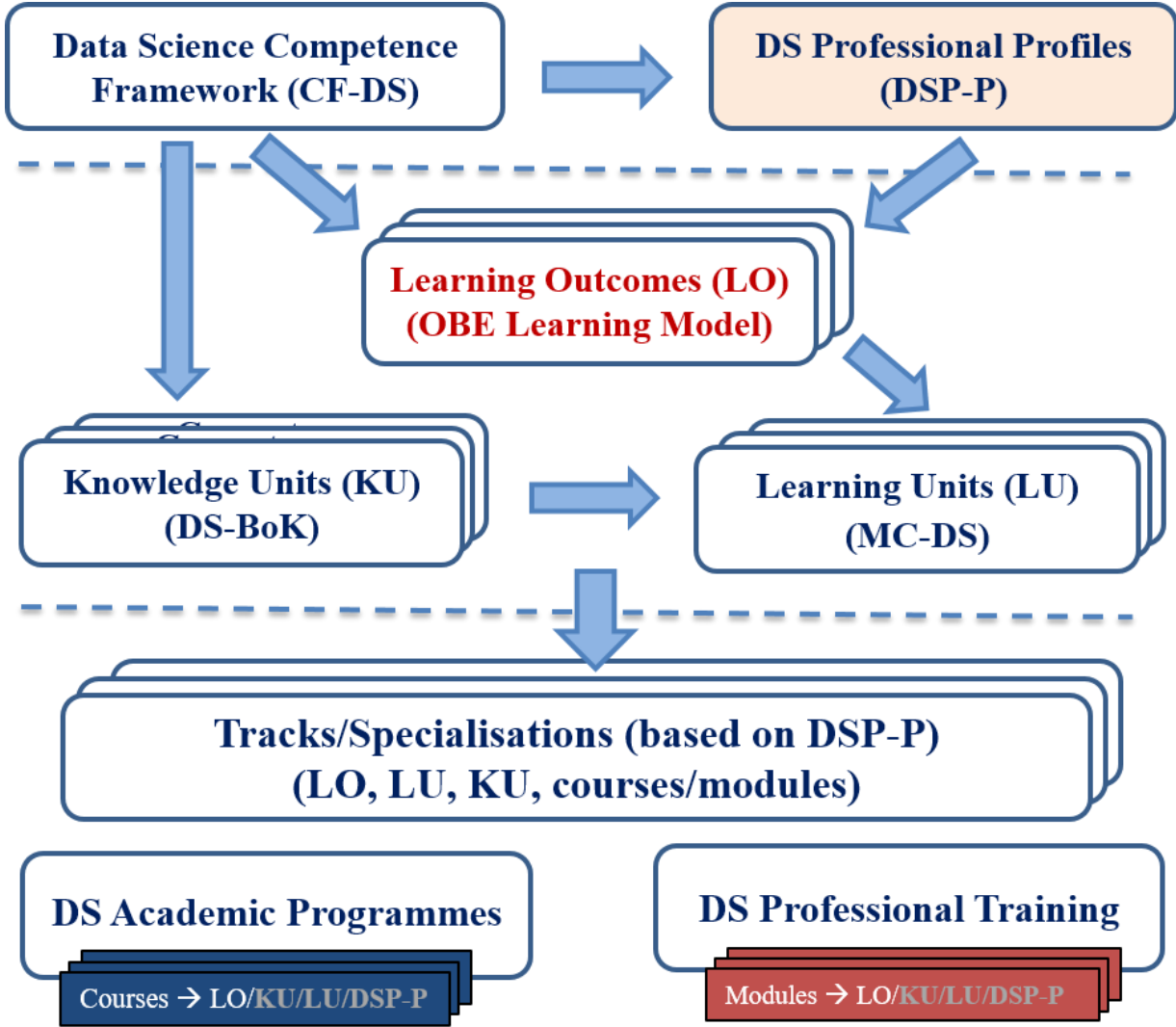

From Competences and DSP Profiles to Learning Outcomes (LO) and to Knowledge Unites (KU) and Learning Units (LU)

- EDSF allow for customized educational courses and training modules design

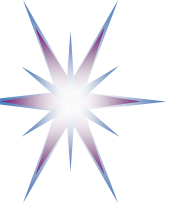

# EDSF Data Model and API

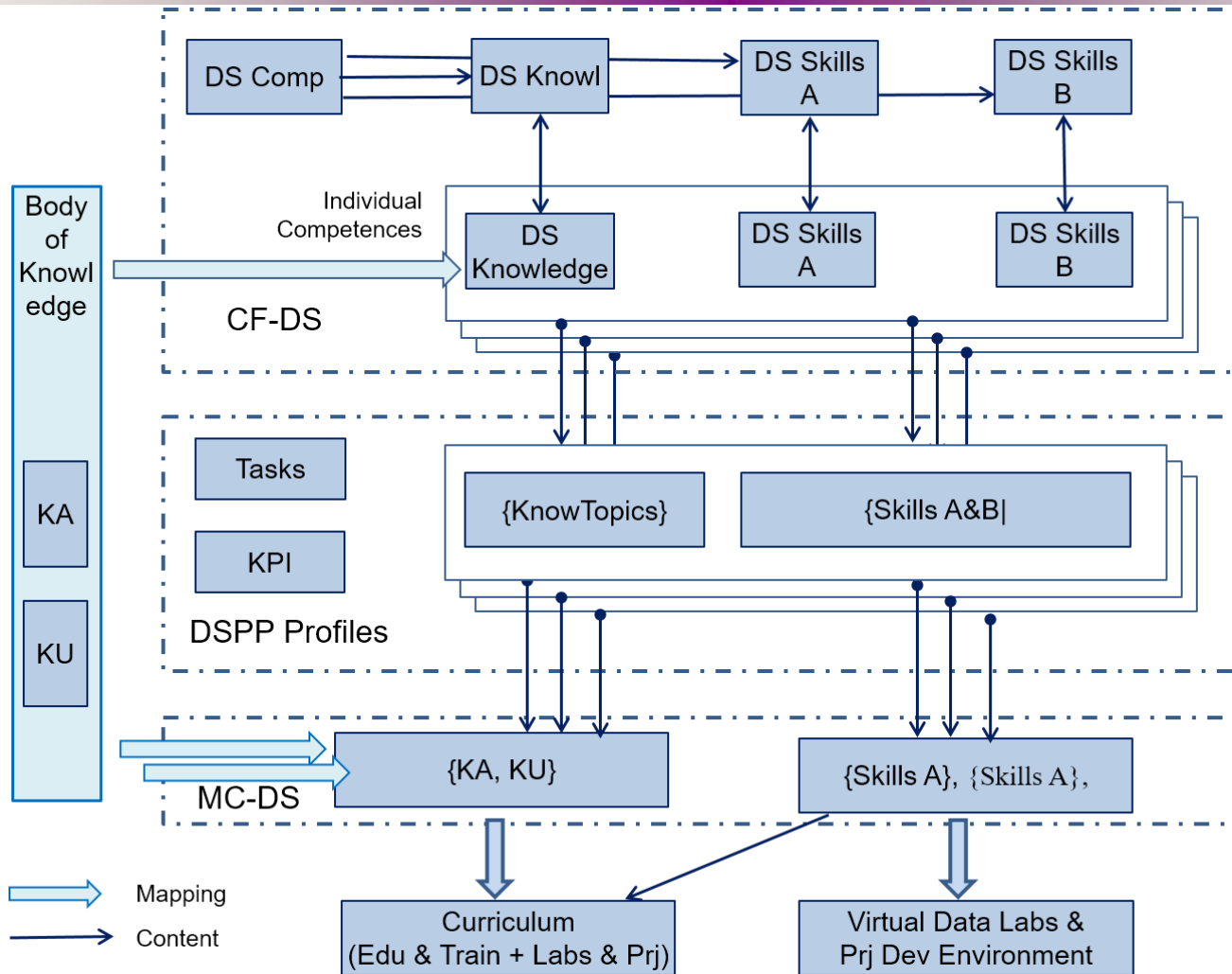

- EDSF API provides access to all EDSF functionality



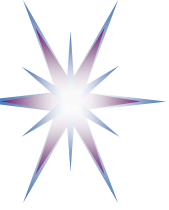

# DSP04 – Data Scientist MC structure

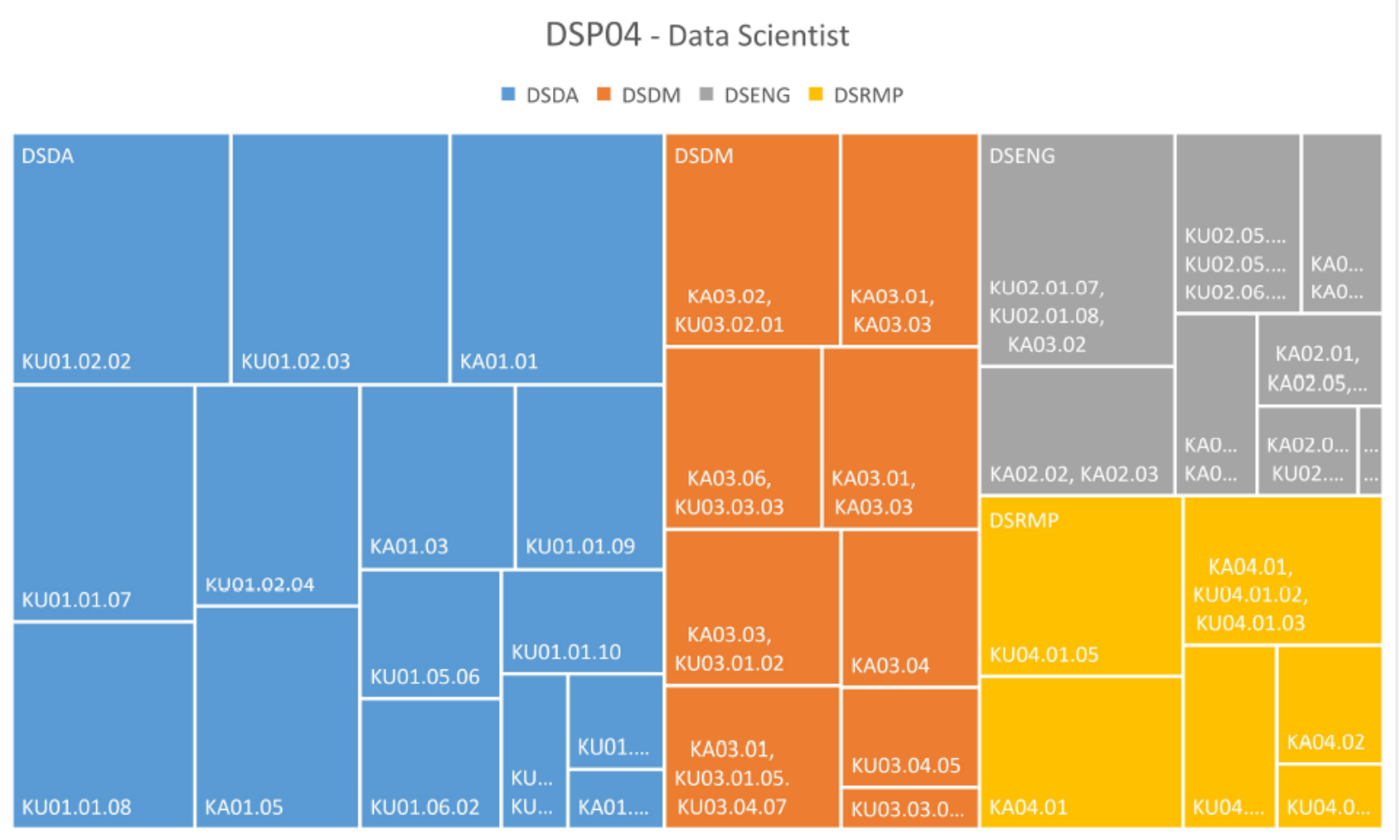



# DSP10 – Data Steward MC structure

DSP10 - Data Steward

■ DSDA ■ DSDM ■ DSENG ■ DSRMP

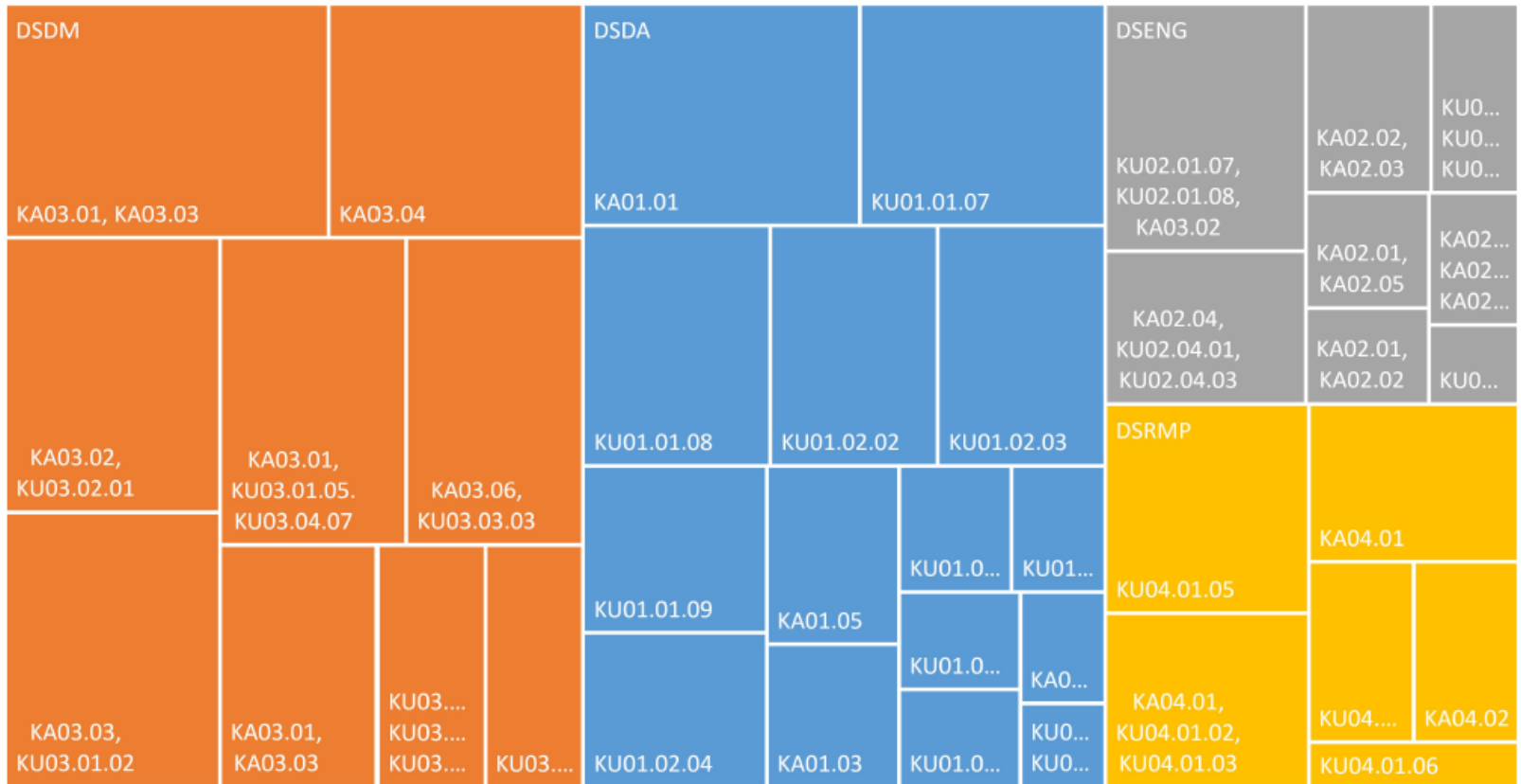

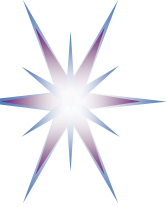

# DSP04 Data Scientist – Required practical skills and Hands-on labs

Data Science curriculum should include the following elements to achieve necessary skills Type B:

- Python (or R) and corresponding data analytics libraries
- NoSQL and SQL Databases (Hbase, MongoDB, Cassandra, Redis, Accumulo, MS SQL, My SQL, PostgreSQL, etc.)
- Big Data Analytics platforms (Hadoop, Spark, Data Lakes, others)
- Real time and streaming analytics systems (Flume, Kafka, Storm)
- Kaggle competition, resources and community platform, including rich data sets, forum and computing resources
- Visualisation software (D3.js, Processing, Tableau, Julia, Raphael, etc.)
- Web API management and web scrapping
- Git versioning system as a general platform for software development
- Development Frameworks: Python, Java or C/C++, AJAX (Asynchronous Javascript and XML), D3.js (Data-Driven Documents), jQuery, others
- **Cloud based Big Data and data analytics platforms and services, including large scale storage systems**
  - **Essential for workplace alignment**

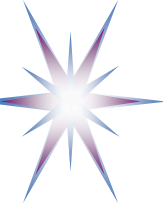

# Hybrid Data Science Education Environment (DSEE)

Hybrid DSEE and VDLabs extends regular compute and storage resources with cloud based

- Microsoft Azure Data Lakes Analytics, Power BI, HDInsight Hadoop as a Service, others
- AWS Elastic MapReduce (EMR), QuickSight, Kinesis and wide collection of open datasets
- IBM Data Science Experience, Data Labs, Watson Analytics
- Google Cloud Platform (GCP)



# Competences assessment and Team building

---

- Data Science competences assessment (benchmarking)
- Data Science team building

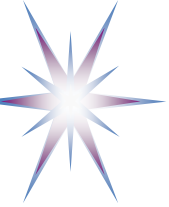

# Individual Competences Benchmarking

## MATCHING – COMPETENCE PROFILES

■ DSP04 - Data Scientist    ■ Candidate - Data Scientist

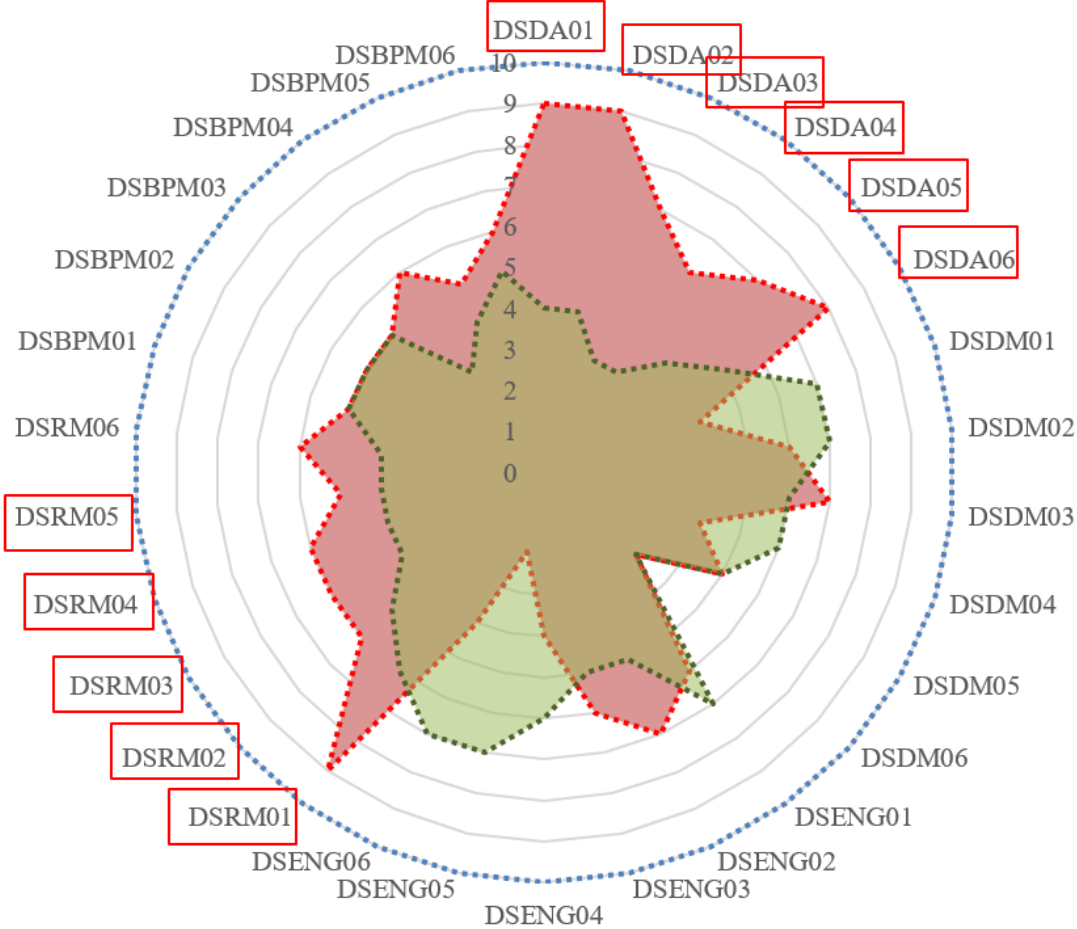

## Individual Education/Training Path based on Competence benchmarking

- Red polygon indicates the chosen professional profile: Data Scientist (general)
- Green polygon indicates the candidate or practitioner competences/skills profile
- Insufficient competences (gaps) are highlighted in *red*
  - DSDA01 – DSDA06 Data Science Analytics
  - DSRM01 – DSRM05 Data Science Research Methods
- Can be use for team skills match marking and organisational skills management

[ref] For DSP Profiles definition and for enumerated competences refer to EDSF documents CF-DS and DSP Profiles.

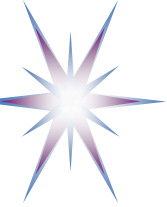

# Competence/Knowledge gap -> Suggested LUs/courses

## GAPS FOR DSP04

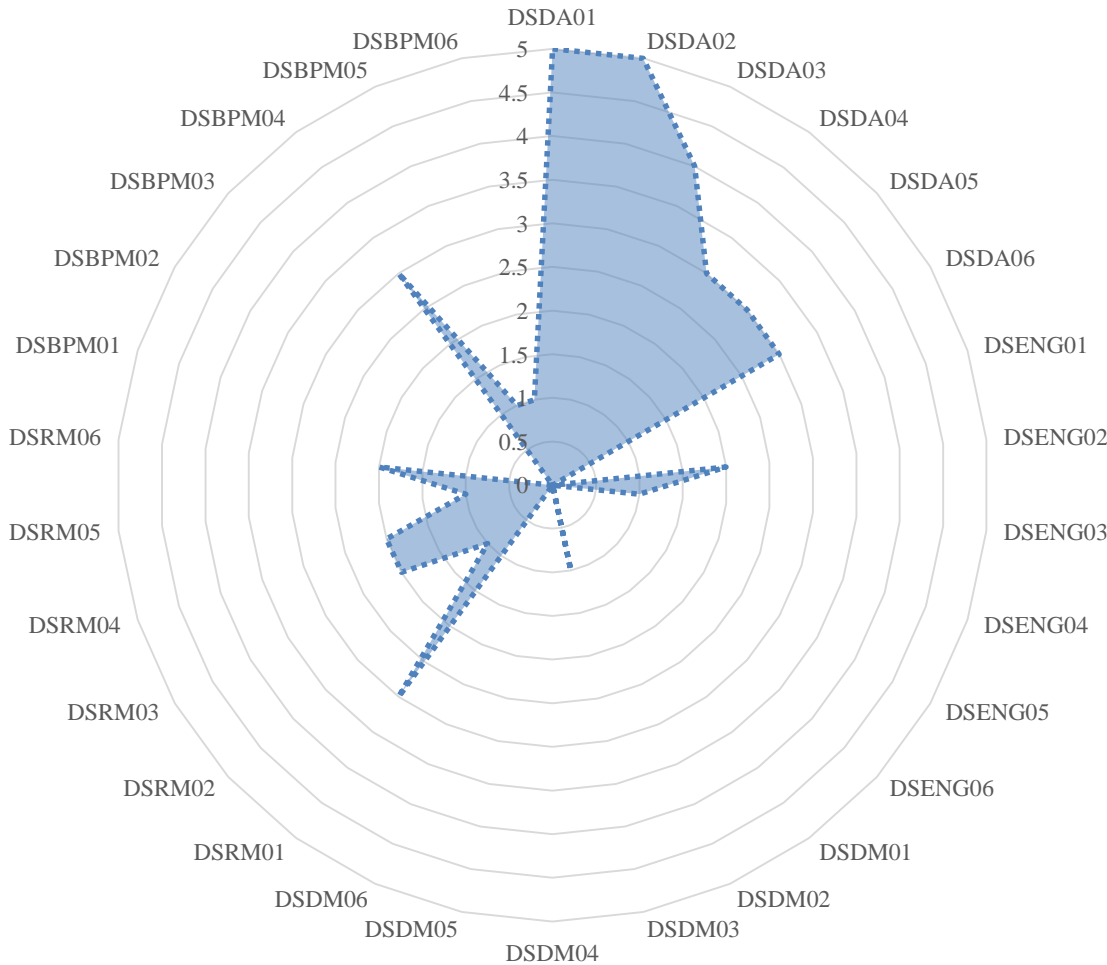

### Recommended courses DSDA

- Statistical Methods
- Machine Learning
- Predictive and Quantitative analytics
- Graph Data Analysis
- Data preparation and preprocessing
- Performance Analysis

### Recommended courses DSRM

- Research Methods and Project Management

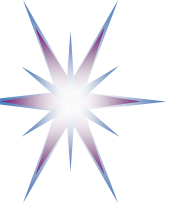

# Building a Data Science Team

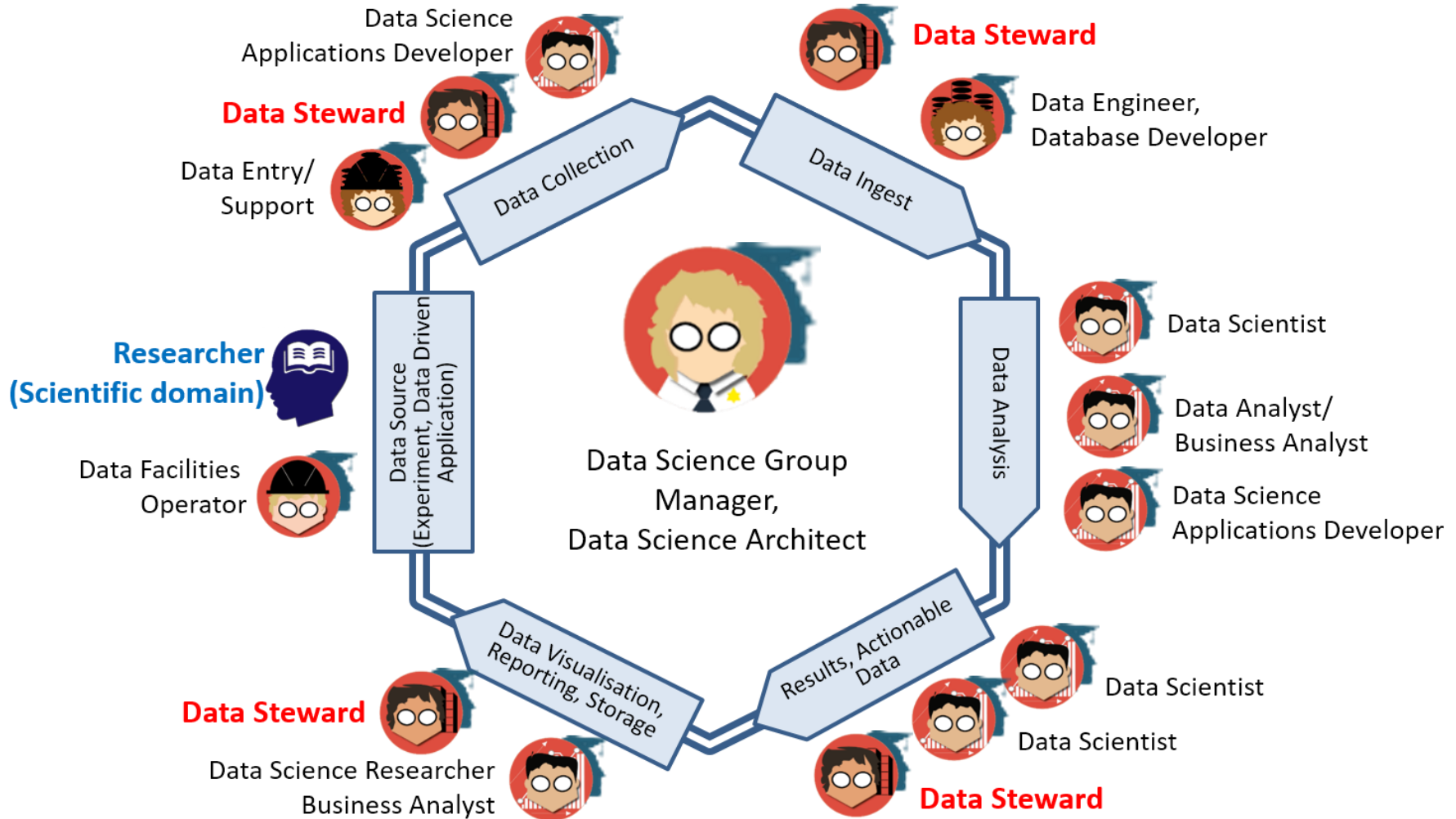





# Data Science or Data Management Group/Department: Organisational structure and staffing - EXAMPLE

## Data Science or Data Management Group/Department

- **(Managing) Data Science Architect (1)**
  - Data Scientist (1), Data Analyst (1)
  - Data Science Application Programmer (2)
  - Data Infrastructure/facilities administrator/operator: storage, cloud, computing (1)
  - **Data stewards**, curators, data librarians, archivists (3-5)
- >> Reporting to CDO/CTO/CEO
- Providing cross-organizational services

Estimated: Group of 10-12 data specialists for research institution of 200-300 research staff.

Growing role and demand for Data Stewards and data stewardship



# Data Stewards – A rising new role in Data Science ecosystem

- Data Stewards as a key bridging role between Data Scientists as (hard)core data experts and scientific domain researchers (HLEG EOSC report)
- Current definition of Data Steward (part of Data Science Professional profiles)
  - Data Steward is a data handling and management professional whose responsibilities include planning, implementing and managing (research) data input, storage, search, and presentation.
  - Data Steward creates data model for domain specific data, support and advice domain scientists/ researchers during the whole research cycle and data management lifecycle.

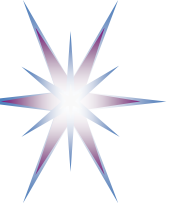

# Data Management and Governance (DMG) and Research Data Management (RDM)

- RDM curricula example
- DAMA Data Management Body of Knowledge (DMBOK)



# Research Data Management Model Curriculum – Part of the EDISON Data Literacy Training

## **A. Use cases for data management and stewardship**

- Preserving the Scientific Record

## **B. Data Management elements (organisational and individual)**

- Goals and motivation for managing your data
- Data formats
- Creating documentation and metadata, metadata for discovery
- Using data portals and metadata registries
- Tracking Data Usage
- Handling sensitive data
- Backing up your data
- Data Management Plan (DMP) - to be a part of hands on session

## **C. Responsible Data Use Section (Citation, Copyright, Data Restrictions)**

## **D. Open Science and Open Data (Definition, Standards, Open Data use and reuse, open government data)**

- Research data and open access
- Repository and self- archiving services
- ORCID identifier for data
- Stakeholders and roles: engineer, librarian, researcher
- Open Data services: ORCID.org, Altmetric Doughnut, Zenodo

## **E. Hands on:**

- a) Data Management Plan design
- b) Metadata and tools
- c) Selection of licenses for open data and contents (e.g. Creative Common and Open Database)

Collaboration with the Research Data Alliance (RDA) on developing model curriculum on Research Data Literacy:

- Modular, Customisable, Localised, Open Access
- Supported by the network of trainers via resource swap board



# KAG3-DSDM: *Data Management group: data curation, preservation and data infrastructure*

DM-BoK version 2 “Guide for performing data management”

– 11 Knowledge Areas

(1) Data Governance

(2) Data Architecture

(3) Data Modelling and Design

(4) Data Storage and Operations

**(5) Data Security**

(6) Data Integration and Interoperability

**(7) Documents and Content**

(8) Reference and Master Data

(9) Data Warehousing and Business Intelligence

**(10) Metadata**

(11) Data Quality

Other Knowledge Areas motivated by RDA, European Open Data initiatives, European Open Data Cloud

**(12) PID, metadata, data registries**

**(13) Data Management Plan**

**(14) Open Science, Open Data, Open Access, ORCID**

**(15) Responsible data use**

- Highlighted in red: Considered (Research) Data Management literacy (minimum required knowledge)

# Data Governance and Stewardship

**Definition:** The exercise of authority, control, and shared decision-making (planning, monitoring, and enforcement) over the management of data assets.

**Goals:**

1. Enable an organization to manage its data as an asset.
2. Define, approve, communicate, and implement principles, policies, procedures, metrics, tools, and responsibilities for data management.
3. Monitor and guide policy compliance, data usage, and management activities.

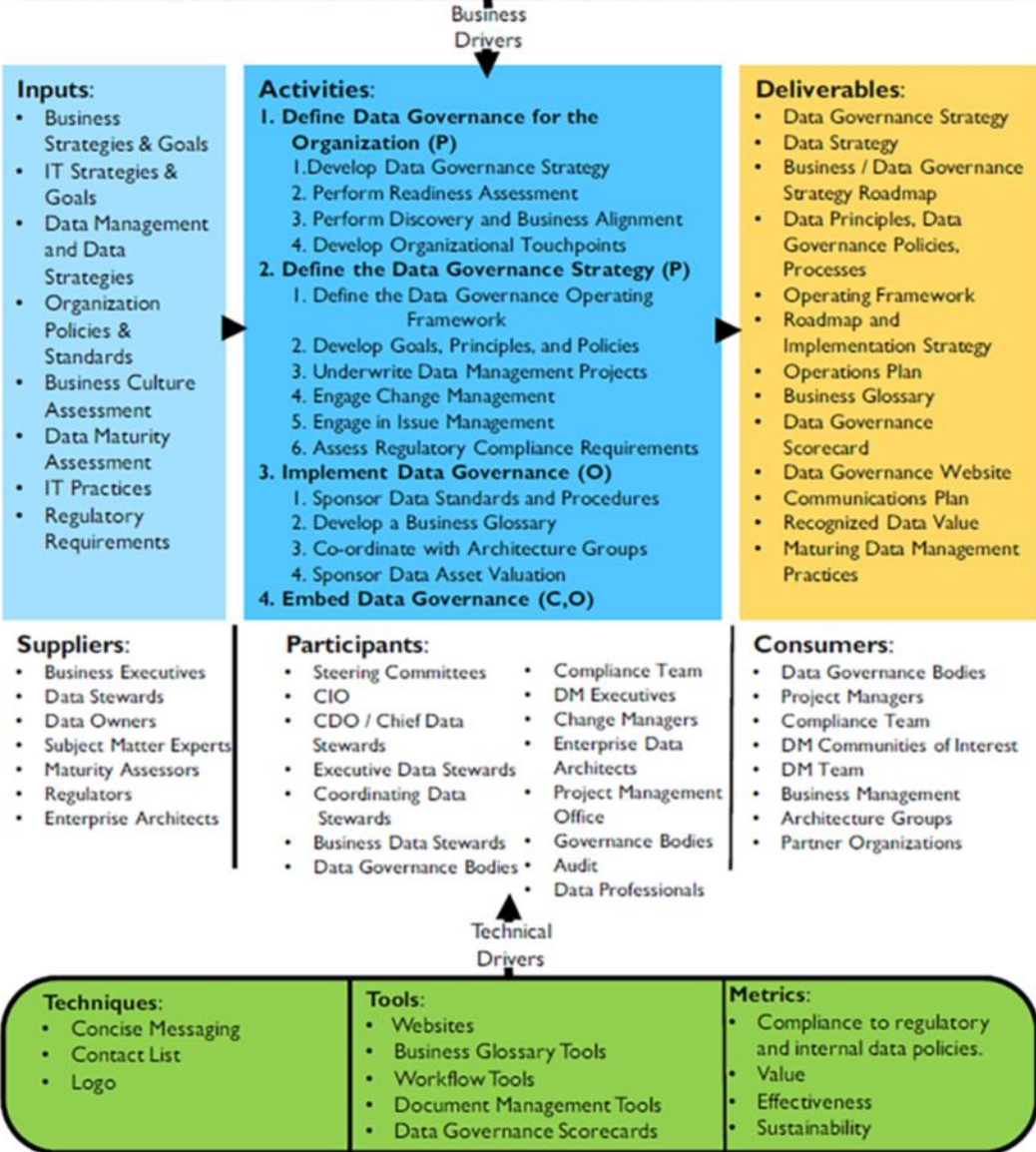

# DMBOK: Data Governance and Stewardship

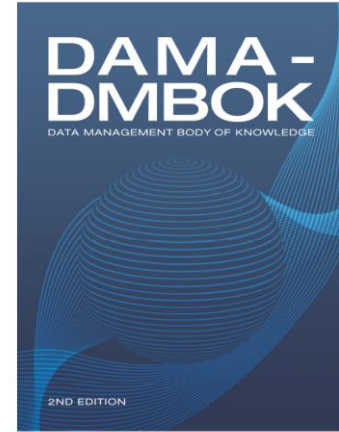

Technics Publications  
BASKING RIDGE, NEW JERSEY

## Scope of a Data Governance Programme

- Strategy
- Policy
- Standards and quality
- Oversight
- Compliance
- Issue management
- Data management projects
- Data asset valuation



# DMBOK: Data Management Principles

## DATA MANAGEMENT PRINCIPLES

Effective data management requires leadership commitment

*Data is valuable*

- Data is an asset with unique properties
- The value of data can and should be expressed in economic terms

*Data Management Requirements are Business Requirements*

- Managing data means managing the quality of data
- It takes Metadata to manage data
- It takes planning to manage data
- Data management requirements must drive Information Technology decisions

*Data Management depends on diverse skills*

- Data management is cross-functional
- Data management requires an enterprise perspective
- Data management must account for a range of perspectives

*Data Management is lifecycle management*

- Different types of data have different lifecycle characteristics
- Managing data includes managing the risks associated with data

- Data is an asset with unique properties
- The value of data can and should be expressed in economic terms
- Managing data means managing the quality of data
- It takes Metadata to manage data
- It takes planning to manage data
- Data management requirements must drive Information Technology decisions
- Data management is cross-functional; it requires a range of skills and expertise
- Data management requires an enterprise perspective
- Data management must account for a range of perspectives
- Data management is lifecycle management
- Different types of data have different lifecycle characteristics
- Managing data includes managing the risks associated with data
- Effective data management requires leadership commitment

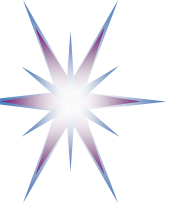

# DMBOK: Data Governance Organisation Parts

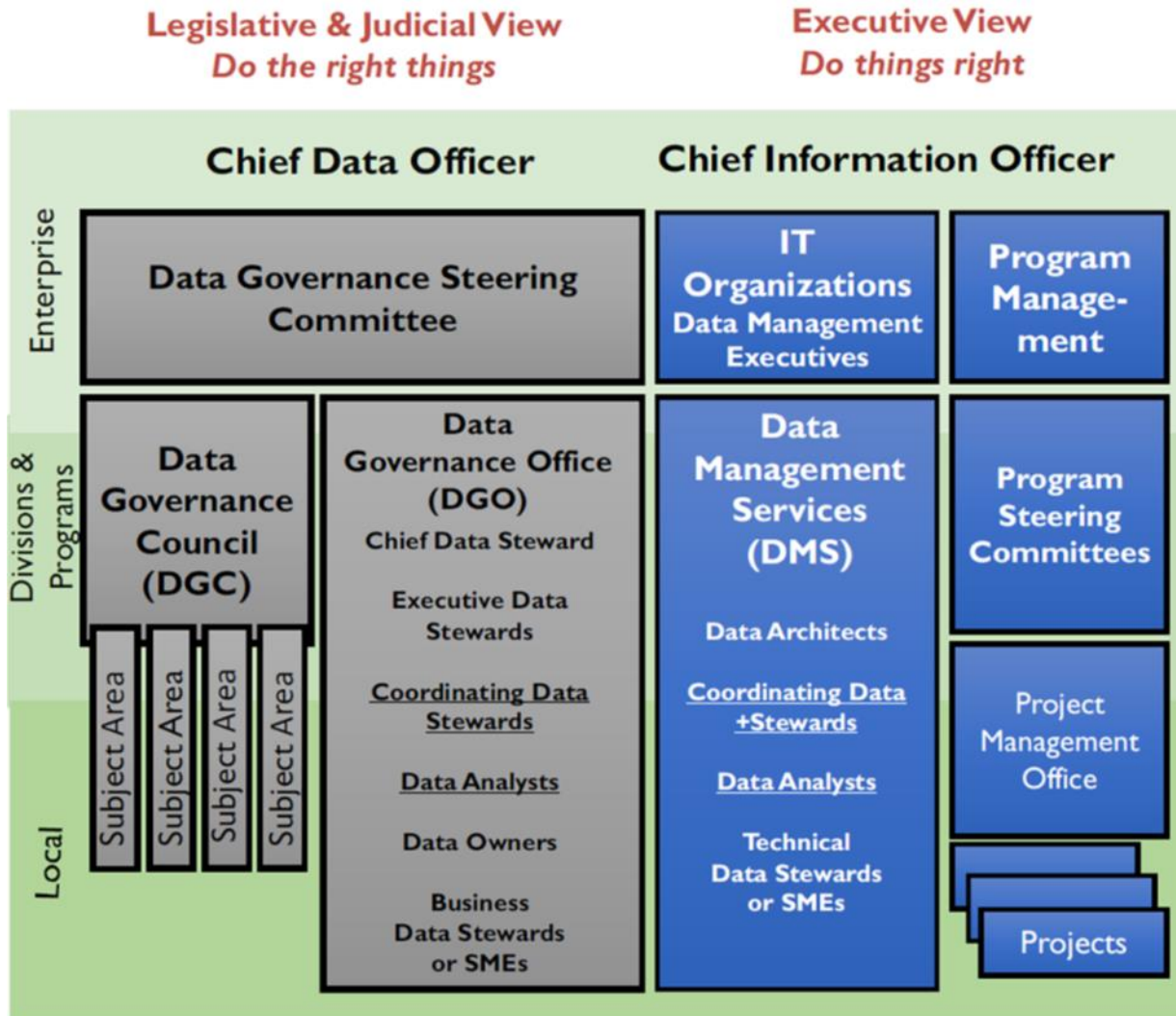

- Separation or governance responsibilities
- Multi-layer
- CDO
- CIO
- Councils





# Data Stewardship

- **Creating and managing core Metadata:** Definition and management of business terminology, valid data values, and other critical Metadata.
- **Documenting rules and standards:** Definition/documentation of business rules, data standards, and data quality rules.
  - High quality data are often formulated in terms of rules rooted in the business processes that create or consume data.
  - Stewards help surface these rules and ensure their consistent use.
- **Managing data quality issues:** Stewards are often involved with the identification and resolution of data related issues or in facilitating the process of resolution.
- **Executing operational data governance activities:** Stewards are responsible for ensuring that, day-to-day and project-by-project, data governance policies and initiatives are adhered to. They should influence decisions to ensure that data is managed in ways that support the overall goals of the organization.

“Best Data Steward is not made but found” DMBOK1 (2009)

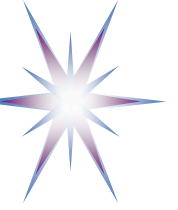

# Discussion: How to become a Data Scientist

- A lot of information and different paths
- There are essential knowledge and competences
  - However most of them require strong background in mathematics, statistics, programming, infrastructure, etc.

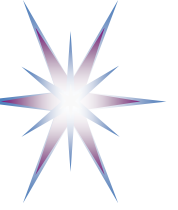

# Discussion: How to become a Data Scientist

- Understand required Data Science and Analytics competences and skills
- Build your own learning path
  - Assess your knowledge and start from basics
  - Statistics is foundation of Data (Science) Analytics
    - Develop statistical/probabilistic thinking
    - Difference between Data Science and statistics
  - Learn from others experience: read blogs, join forums and communities
  - Decide about academic degree, professional certificate, self-education/training, join local Meetup
- Start applying for job
  - Remember variety of Data Scientist roles and profiles
  - Understand what company is actually looking for

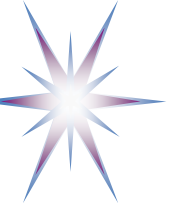

# Becoming a Data Scientist by Swami Chandrasekaran (2013) <http://nirvacana.com/thoughts/becoming-a-data-scientist/>

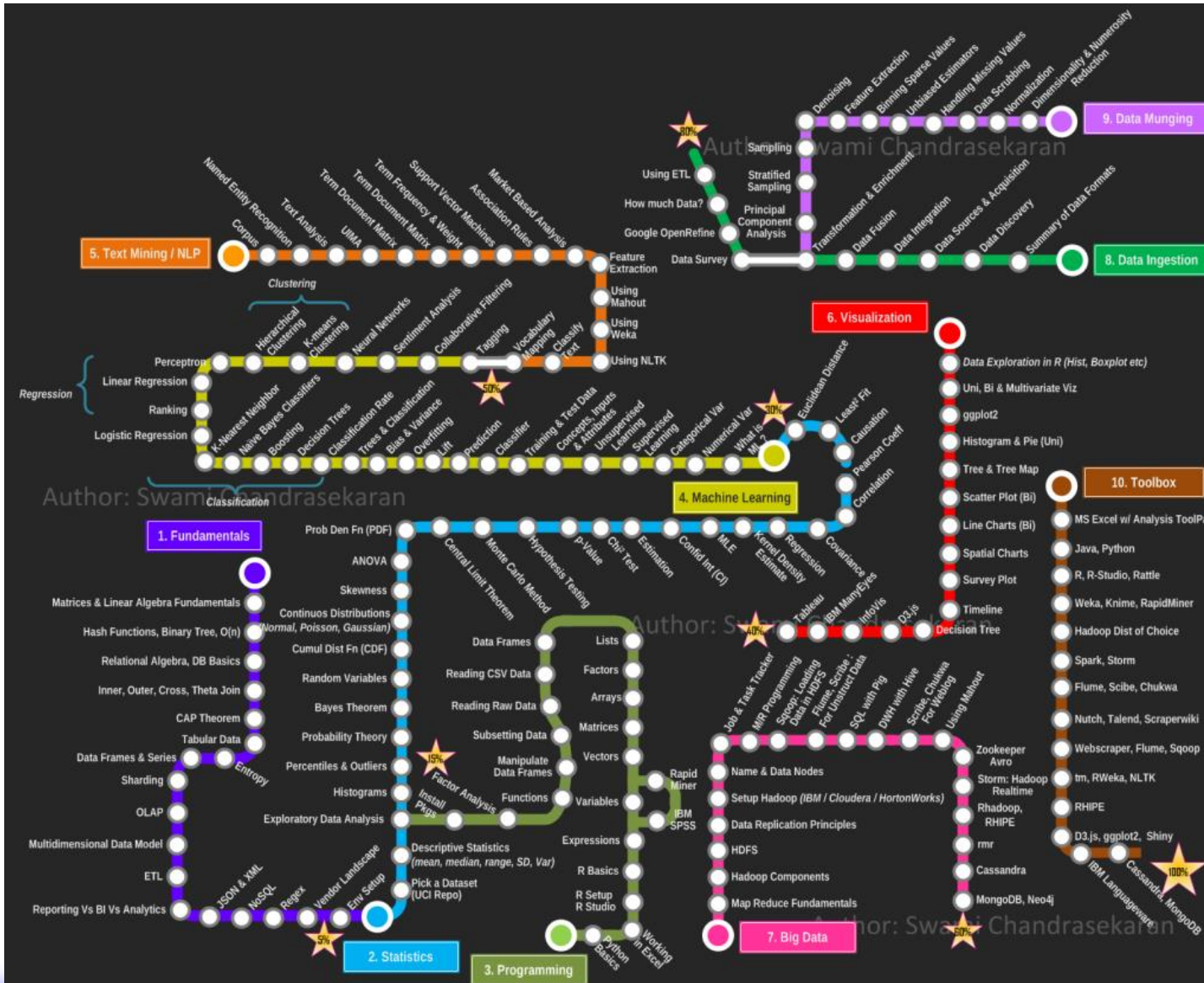

- Good and practical advice how to learn Data Science, step by step
- Follow the route

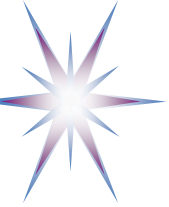

# Online Educational and training resources

---

- LinkedIn Education
- Microsoft Virtual Academy
- (IBM – in transition)
- DataCamp
- Coursera, Udacity
- Certification and training PMI, DAMA, IIBA

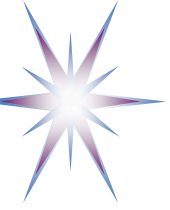

# Open Data and Educational Datasets

- Amazon Web Services (AWS)
- Google
- Microsoft Azure
- Kaggle
- KD Nuggets
- Emerging - <https://www.datasciencepro.eu/>



# Links to Workshop Resources

- EDISON Workshop home  
<https://github.com/EDISONcommunity/EDSF/tree/master/EDSFcurriculaDesign>
- EDISON Data Science Framework Release 2 (EDSF)  
<https://github.com/EDISONcommunity/EDSF>
- (old <http://edison-project.eu/edison-data-science-framework-edsf>)

## Component documents

CF-DS – Data Science Competence Framework

[https://github.com/EDISONcommunity/EDSF/blob/master/EDISON\\_CF-DS-release2-v08.pdf](https://github.com/EDISONcommunity/EDSF/blob/master/EDISON_CF-DS-release2-v08.pdf)

DS-BoK – Data Science Body of Knowledge

[https://github.com/EDISONcommunity/EDSF/blob/master/EDISON\\_DS-BoK-release2-v04.pdf](https://github.com/EDISONcommunity/EDSF/blob/master/EDISON_DS-BoK-release2-v04.pdf)

MC-DS – Data Science Model Curriculum

[https://github.com/EDISONcommunity/EDSF/blob/master/EDISON\\_MC-DS-release2-v03.pdf](https://github.com/EDISONcommunity/EDSF/blob/master/EDISON_MC-DS-release2-v03.pdf)

DSPP – Data Science Professional profiles

[https://github.com/EDISONcommunity/EDSF/blob/master/EDISON\\_DSPP-release2-v05.pdf](https://github.com/EDISONcommunity/EDSF/blob/master/EDISON_DSPP-release2-v05.pdf)

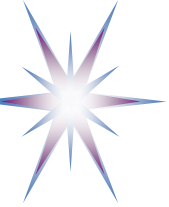

# EDISON Initiative Online Presence

- EDSF github project - <https://github.com/EDISONcommunity/EDSF>
  - Component documents CF-DS, DS-BoK, MC-DS, DSPP
- EDISON Community work area and discussions - <https://github.com/EDISONcommunity/EDSF/wiki/EDSFhome>
- Mailing list - [edison-net@list.uva.nl](mailto:edison-net@list.uva.nl)
- EDISON project website (still active) <http://edison-project.eu/>
  - EDISON Data Science Framework Release 2 (EDSF), 3 July 2017  
<http://edison-project.eu/edison-data-science-framework-edsf>
- Data Science Community Portal (<http://datasciencepro.eu>)
  - To host future EDISON Community initiatives



This work is licensed under the Creative Commons Attribution 4.0 International License.  
To view a copy of this license, visit <http://creativecommons.org/licenses/by/4.0/>



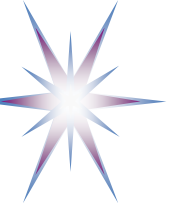

# Additional materials

---

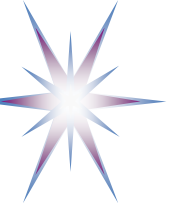

# Becoming a Data Scientist by Swami Chandrasekaran (2013) <http://nirvacana.com/thoughts/becoming-a-data-scientist/>

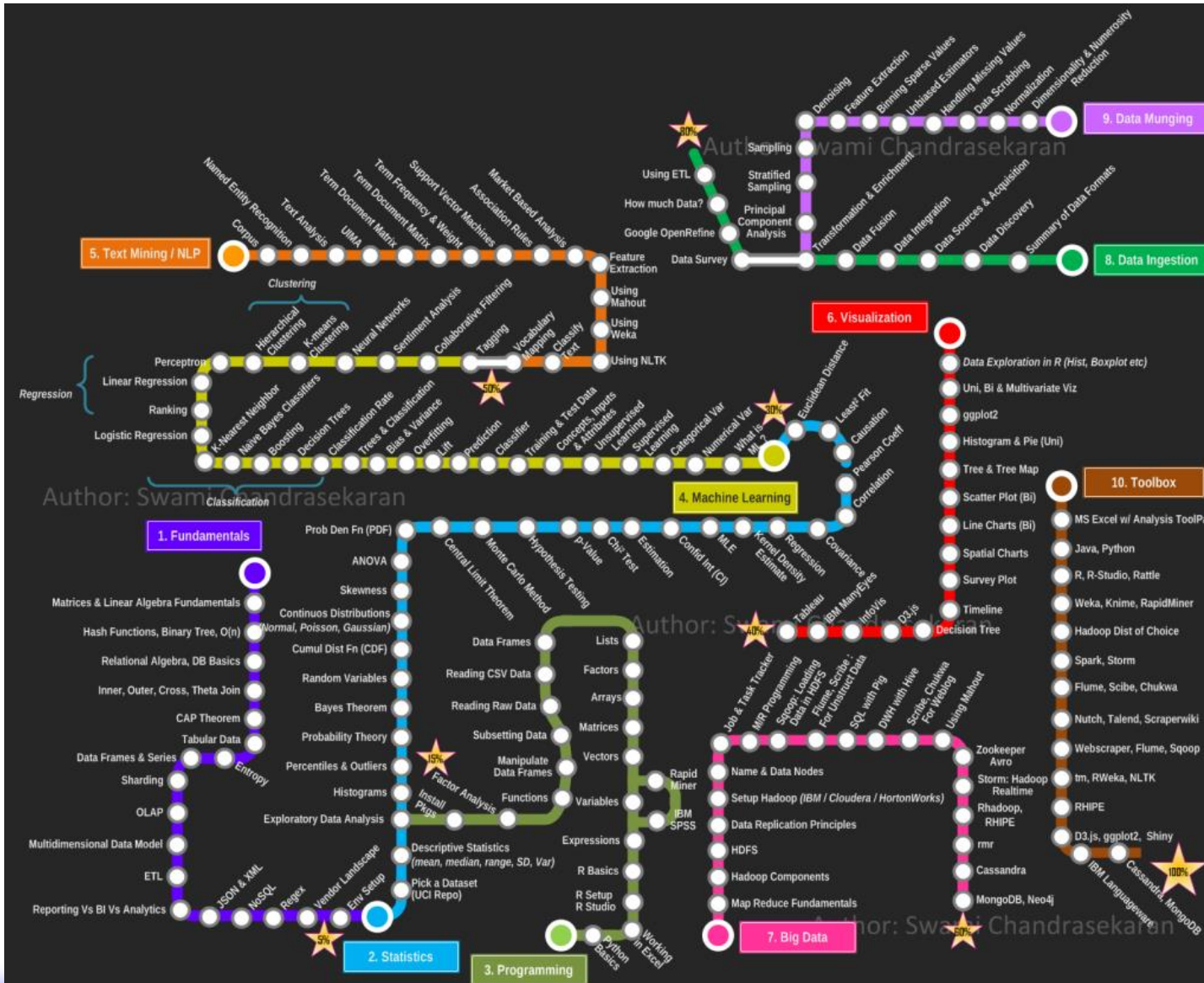

- Good and practical advice how to learn Data Science, step by step
- Follow the route



# Data Science and Data Mining

- Data mining (knowledge discovery from data)
  - Extraction of interesting (non-trivial, implicit, previously unknown and potentially useful) patterns or knowledge from huge amount of data
- Alternative names
  - Knowledge discovery (mining) in databases (KDD), knowledge extraction, data/pattern analysis, data archeology, data dredging, information harvesting, business intelligence, etc.
- Watch out: Is everything “data mining”?
  - Simple search and query processing
  - (Deductive) expert systems



# Types of Data Mining (branch of Data Analysis)

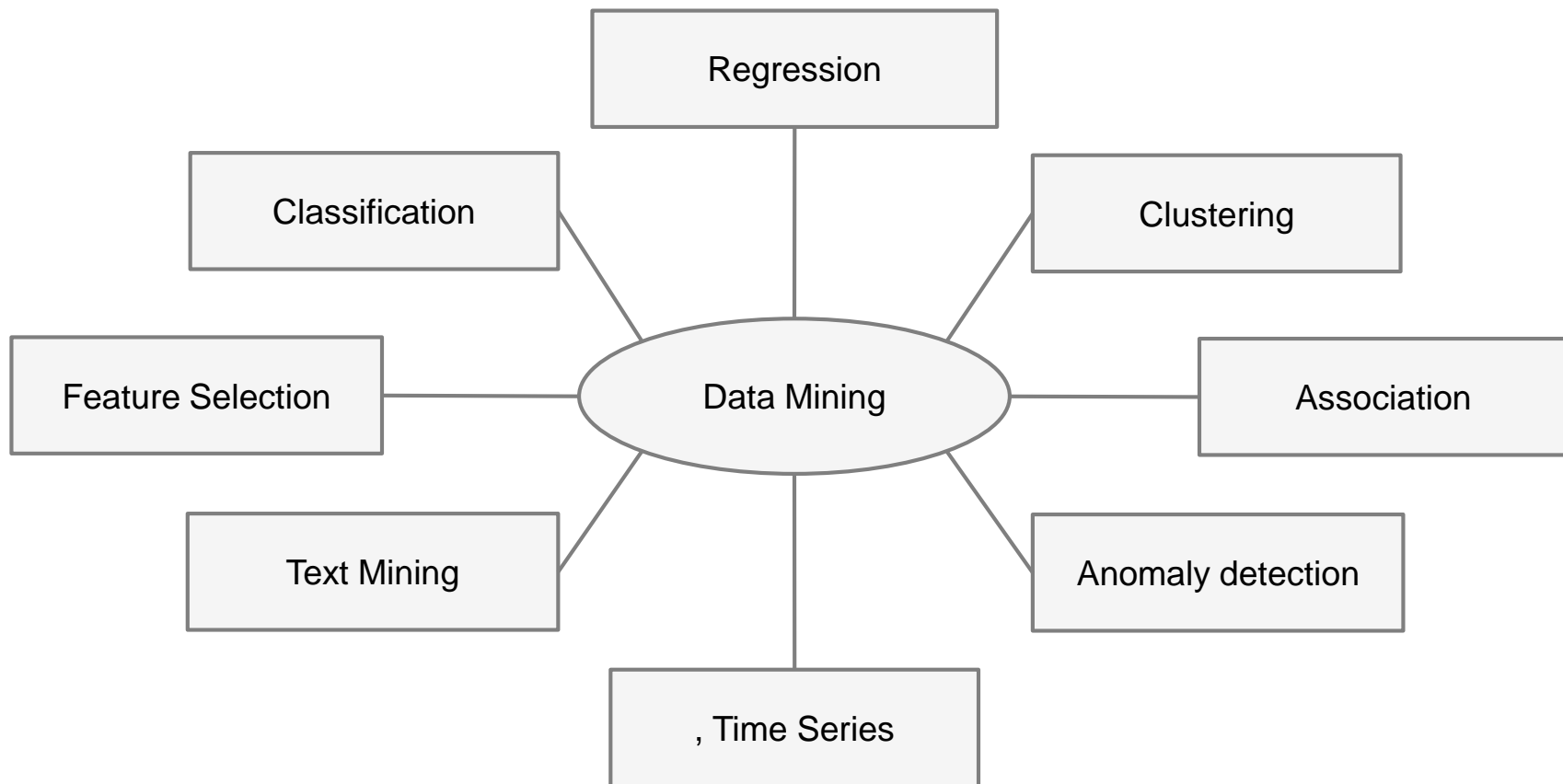

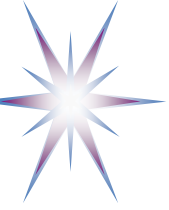

# Data Mining: Confluence of Multiple Disciplines

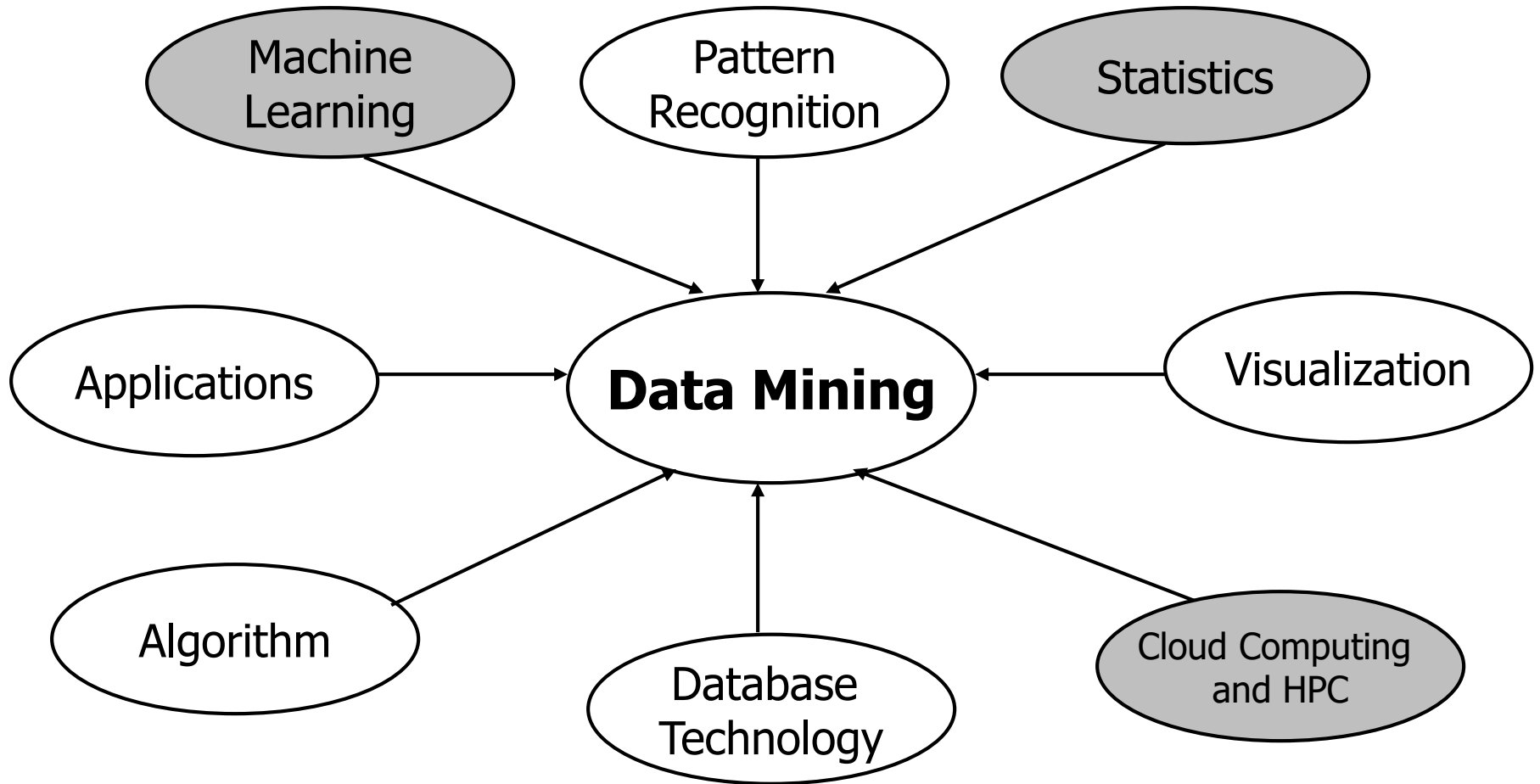

# CRISP DM process: Processes and Data Lifecycle

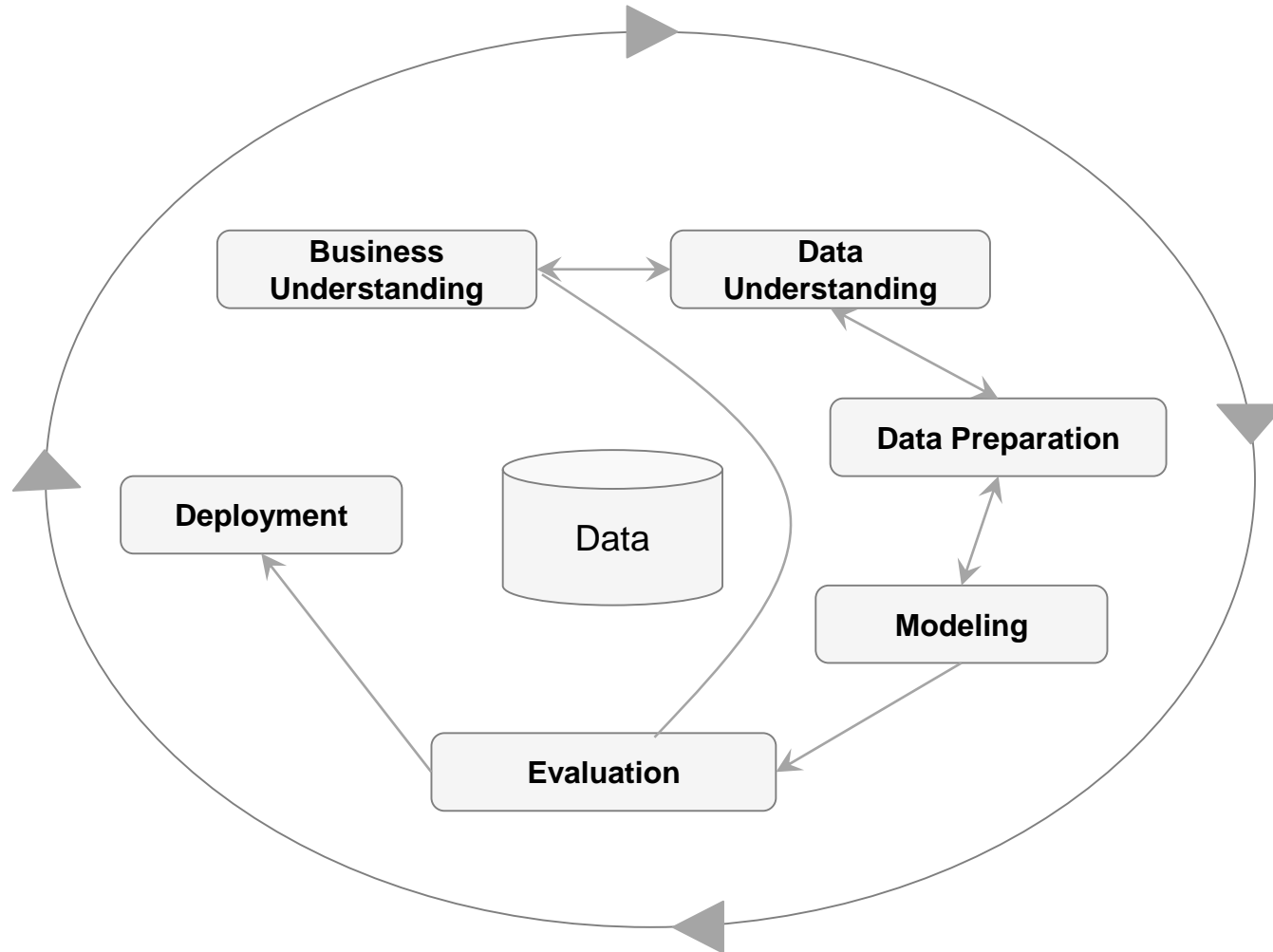

Cross Industry Standard Process for Data Mining (CRISP-DM)



# Process of Data Analysis

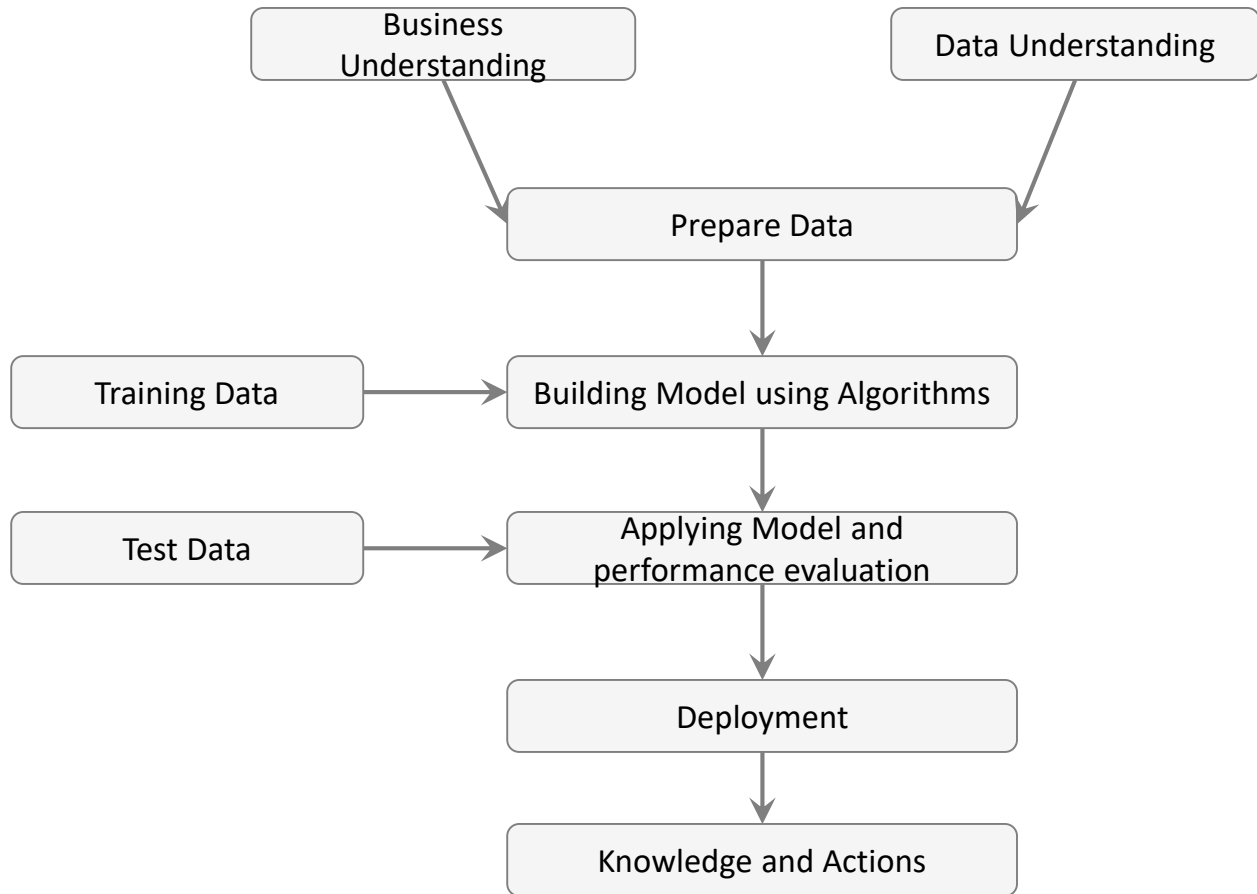

**1. Prior Knowledge**

**2. Preparation**

**3. Modeling**

**4. Application**

**5. Knowledge**